

Digital Brand Guidelines

Version
August | 2014



General

01 Introduction

- 1.1 Overview
- 1.2 Quality standards

02 Logo

- 2.1 Overview
- 2.2 Which logo to use?
- 2.3 Logo size and clear space

03 Colours

- 3.1 Overview
- 3.2 Colour palette
- 3.3 HTML colour attributes

04 Imagery

- 4.1 Overview
- 4.2 Photography
- 4.3 Look and feel

05 Typefaces

- 5.1 Overview
- 5.2 English digital fonts
- 5.3 Web fonts

06 Digital circle text box

- 6.1 Visual presentation
- 6.2 Variations of the digitala circle text box
- 6.3 Colours and fonts usage
- 6.4 Appearance on digital platforms

Websites and Apps

07 Grid system

- 7.1 Overview
- 7.2 Website grid system
- 7.3 Grid variations #1
- 7.4 Grid variations #2
- 7.5 Mobile grid
- 7.6 Tablet grid

08 Website

- 8.1 Brandmark build-up
- 8.2 Where to use the logo?
- 8.3 Logo misuse on websites
- 8.4 Global masthead
- 8.5 Header
- 8.6 Dropdown menu
- 8.7 Spotlight widget
- 8.8 Spotlight function
- 8.9 Footer
- 8.10 Call to action
- 8.11 Favicon
- 8.12 Sign-in box

Iconography

09 Iconography categories

- 9.1 User interface and navigation icons
- 9.2 Services, products and features icons
- 9.3 Illustrations

10 Iconography design princi-

- 10.1 Pixel perfect iconography
- 10.2 Skeuomorphic flat design
- 10.3 Geometrical shapes
- 10.4 Icon grid
- 10.5 Perspective
- 10.6 Rule of shading

11 Iconography's colours and backgrounds

- 11.1 Ooredoo colour palette
- 11.2 Colour rules
- 11.3 Colour codes
- 11.4 Icon Backgrounds

12 Application

- 12.1 Applying design principles :
Directory icon
- 12.2 Applying design principles :
Search icon
- 12.3 Applying design principles :
Down arrow icon
- 12.4 Applying design principles :
Forum icon
- 12.5 Applying colours: User Interface
and navigation icons

- 12.6 Applying design principles :
Services, products, and features icons
- 12.7 Applying colours and background:
Services, products, and features icons
- 12.8 16px adjustment

13 Call to action - CTA

- 13.1 Clear space
- 13.2 Minimum width and height
- 13.3 Colour principles
- 13.4 Font (family, colour, size)
- 13.5 Behaviour states (over and click)
- 13.6 Application

14 Iconography library

- 14.1 Listing nomenclature
- 14.2 Asset listing
- 14.3 Conclusion

Social media

15

Social media creative guidelines

- 15.1 Social media icons
- 15.2 Facebook
- 15.3 Twitter
- 15.4 Youtube
- 15.5 Pinterest
- 15.6 Instagram
- 15.7 Google +
- 15.8 LinkedIn
- 15.9 Tumblr

16

Social media management guidelines

- 16.1 Introduction
- 16.2 Channel set up
- 16.3 Content strategy
- 16.4 Hashtag planning
- 16.5 Paid, owned and earned
- 16.6 Paid media approach
- 16.7 Reporting
- 16.8 Influencer engagement
- 16.9 Applications
- 16.10 Best practices
- 16.11 Support links

Advertising

17

Banners

- 17.1 Overview
- 17.2 Brand Banners
 - 17.2.1 Logo placement
 - 17.2.2 Square logo
 - 17.2.3 Logo spacing
 - 17.2.4 Headline placement
 - 17.2.5 Endslate
 - 17.2.6 Banner example
- 17.3. Tactical banners
 - 17.3.1 Visual, Logo and Headline usage.
 - 17.3.2 Banner Example

18

Emailers

- 18.1. Overview
 - 18. 1.1 - Emailer
 - 18. 1.2 - Newsletter
- 18. 2. Logo
 - 18. 2.1 - Logo placement
 - 18. 2.2 - Logo size
 - 18. 2.3 - Logo clear space
- 18. 3. Content elements
 - 18. 3.1 - Index
 - 18. 3.2 - Header image dimensions
 - 18. 3.3 - Header image format
 - 18. 3.4 - Header image headline
 - 18. 3.4.1 - Headline within the circle text box
 - 18. 3.4.2 - Headline underneath the image

Digital Brand Guidelines

Table of Contents

18. 3.5 - CTA

18. 3.6 - Footer

18. 4. Content Layout

18. 4.1 - Grid structure

18. 4.2 - Typography

18. 4.3 - Emailer - Single article layout

18. 4.4 - Newsletter - Multiple articles
layout

18. 5. Analytics

18. 5.1 - Email Service Provider reports

18. 5.2 - Google Analytics reports

18. 6. Best Practices

18. 6.1 - Email best practices

General

This Digital Brand Guidelines contains all the major tools and resources you will need to use the **Ooredoo** digital regional brand identity and elements successfully.

Precise information, design rules and practical examples are contained in the following pages.

Any brand or visual identity elements or asset not included in these guidelines is not recommended.

For artwork approvals and advice about using the brand identity, please contact Havas WorlWide Middle East.

1.2 Quality Standards

Before we start and go deeper into the technical details let us share some design principals which may help you to acquire the essential digital quality standards of **Ooredoo**.

Graphic assets

For the best visual result always use vector graphics when you work in your digital image editing application.

Logos, brandmark elements, social media icons, arrows look much better and sharper in resizable high-resolution vector formats (AI, EPS, SVG) than in pixel version.

Try to avoid copy/paste low quality logos, images into the artwork or to the website directly. It could lead to a wrong visual user experience and could distort the brand exposure.

Choosing the right image

An eye-catching piece of art or an engaging texture can awaken the senses and attract the visitors - enticing them to pay attention to click and learn more. All Oordeo communications should reflect this mission by using the approved art and texture.

Image “hygiene”

Stock image sites provide good quality images, but in some cases we need to retouch the images before we use it. When you're implementing a photography or macro shots, the subject should be presentable, crystal clear, and good-looking.

This is what we call "image hygiene."

Take some look over small details and make sure that everything is clean and in order. The designer should spend some extra time on retouching the image removing dust, dirt, useless parts, noise or pixels from the background before you use it in the actual design.

1.2 Quality Standards

Appropriate imagery

It's very important to respect our visitors religion or views by using appropriate imagery and language. Any form of violence, nudity, racism, not acceptable in any Ooredoo mediums.

Example: Female's persons body should be covered on all photos, even if the original images have them uncovered. In this case the designer should retouch the images to create appropriate and acceptable visuals which won't disturb our visitors.

HiDPI resolution

Ooredoo follows the latest digital trends and supports HiDPI enabled websites. HiDPI stands for High resolution Dots Per Inch when referring to displays. For example, the Apple © Retina displays found on the iPhone, iPad, and MacBook Pro are HiDPI.

All Ooredoo websites should have two sets of imagery on server side. A "@1" set (regular) and a "@2" set (double) which is twice the pixel size of the regular.

The regular set will displayed automatically on regular computers and the "@2" will be loaded on high-resolution ones like a Macbook Pro.

Logo

- 2.1 Overview
- 2.2 Which logo to use?
- 2.3 Logo size and clear space

The **Ooredoo** logo and colour are the vital basic elements of our visual identity.

They are its foundation.

Your commitment to ensuring they always appear as shown them here will protect the integrity of the **Ooredoo** brand name and create the best results.

2.2 Which logo to use?

Having a logo for your header helps keep your icon in the eyes of the user at all time maximise your brand presence and exposure. We have two logo iterations for different representations: horizontal and stacked.



Horizontal logo

Having a logo for your header helps keep your icon in the eyes of the user at all time maximise your brand presence and exposure. We have two logo iterations for different representations: horizontal and stacked.



Stacked logo

The stacked logo has been designed to accommodate applications insufficient room to use the horizontal logo version. All the standards for the horizontal logo apply to the stacked logo.

2.3 Logo size and clear space

The logo is a precious visual element that needs a proper display size room to breathe. We can maximise visibility and impact simply by creating and protecting this invisible clear space around it. It is kept free of graphics, text and other marks. It also defines the minimum distance between the logo and the edge of the page.



200 px

Logo size

Our logo always displays with a minimum 227px width.



Clear space

This is the minimum recommended clear space area and more space around the logotype will always aid visibility.

The clear space around our logo is equal to quarter of one logo circle (1/4X)



Colours

- 3.1 Overview
- 3.2 Colour palette
- 3.3 HTML colour attributes

Ooredoo uses red and grey as primary and an array of colors for secondary colors.

Used in combination, they are strong brand signifiers and fundamental to our identity. It's important they are only used on specific interfaces and applications so that they remain powerful and effective brand elements.

3.2 Colour palette: Primary colours

Primary graphic and typographic elements such as menus, navigation bars, and headlines should always use the core **Ooredoo** colour palette where possible, as shown here. RGB colour references are provided to help you achieve accurate colour matching in on-line applications.

	<p>Ooredoo Red</p> <p>R: 237 G: 28 B: 36 Hex: ED1C24</p>		<p>Ooredoo Dark Grey</p> <p>R: 90 G: 90 B: 90 Hex: 5A5A5A</p>		<p>Ooredoo Light Grey</p> <p>R: 209 G: 210 B: 211 Hex: #D1D3D4</p>		<p>Pure White</p> <p>R: 255 G: 255 B: 255 Hex: FFFFFFFF</p>
---	--	---	---	---	--	---	---

3.2 Colour palette: Secondary colours

The secondary colour palette communicates the vibrancy of the spectrum of human expression. Rainbow colours. RGB colour references are provided to help you achieve accurate colour matching in on-line applications.

								
R: 255 G: 245 B: 114 Hex: FFF572	R: 254 G: 189 B: 59 Hex: FEBD3B	R: 242 G: 106 B: 54 Hex: F26A36	R: 125 G: 206 B: 241 Hex: 7DCEF1	R: 0 G: 189 B: 242 Hex: 00BDF2	R: 23 G: 27 B: 96 Hex: 171B60	R: 182 G: 219 B: 166 Hex: B6DBA6	R: 98 G: 107 B: 70 Hex: 62BB46	R: 0 G: 107 B: 53 Hex: 006B35
								
R: 156 G: 188 B: 205 Hex: 9CBCCD	R: 61 G: 85 B: 103 Hex: 3D5567	R: 242 G: 106 B: 58 Hex: 22303A	R: 247 G: 179 B: 204 Hex: F7B3CC	R: 232 G: 113 B: 171 Hex: E871AB	R: 132 G: 0 B: 85 Hex: 840055	R: 165 G: 219 B: 219 Hex: A5DBDB	R: 71 G: 191 B: 175 Hex: 47BFAF	R: 0 G: 64 B: 47 Hex: 00402F
								
R: 204 G: 179 B: 215 Hex: COB3D7	R: 142 G: 51 B: 166 Hex: 8E5BA6	R: 56 G: 20 B: 96 Hex: 381460	R: 208 G: 178 B: 164 Hex: D0B2A4	R: 114 G: 99 B: 93 Hex: 72635D	R: 69 G: 63 B: 61 Hex: 453F3D			

3.3 HTML colour attributes

When creating HTML/CSS table always use the primary colour codes from our palette. The table below lists them all, along with their hexadecimal values.

Hex code	
#524A48	Super Header
#524A48	Header
#524A48	Subheader
#ED1C24	Header
#524A48	Running copy Ultrices lorem sit amet diam. Aliquam sollicitudin tristique nulla vis et, condimentum in, congue eu, tellus phasellus
#ED1C24	Link

Imagery

- 4.1 Overview
- 4.2 Photography
- 4.3 Look and feel

Ooredoo images needs to be inspirational and aspirational without being exclusive. Use images that depicts positive energy and stories. The subject matter should be evocative, expressive and active.

4.2 Photography

The regional and local cultural values must be taken into consideration when conducting a photo-shoot to ensure the **Ooredoo** image assets are always relevant to our audience.



4.3 Look and feel

Our photography can be defined in two levels: consumer level, and business level, please see examples below.

Consumer



Business



Typefaces

- 5.1 Overview
- 5.2 English digital fonts
- 5.3 Web fonts

Typography is fundamental to the **Ooredoo** distinctive brand identity. It is a powerful brand signifier in its own right, bringing personality and consistency to all communication and infusing everything it touches with the essential **Ooredoo** look and feel.

5.2 English digital fonts

Our primary typeface **Ooredoo-Beta** is a modern font which has its own individual contemporary rounded characteristic. **Futura**, our secondary typeface is a neutral, clean typeface that have great clarity, legibility and could be used on a wide variety of applications and styles individually and together. **Arial** is secondary substitute font for other systems.

Ooredoo-Beta Font Family

aA123

ABCDEFGHIJKLMNOPQRSTUVWXYZ
abcdefghijklmnopqrstuvwxyz
0123456789

Ooredoo-Beta is our primary typeface. Within screen applications it should be used for headlines, headings and large texts.

Futura Font Family

aA123

ABCDEFGHIJKLMNOPQRSTUVWXYZ
abcdefghijklmnopqrstuvwxyz
0123456789

Futura is our secondary typeface. It is used primarily for body copy or small texts being more legible at these sizes.

Arial Font Family

aA123

ABCDEFGHIJKLMNOPQRSTUVWXYZ
abcdefghijklmnopqrstuvwxyz
0123456789

This is NOT a corporate font. This should be programmed into the code as a fall back font In case the browser does not recognise Futura nor Ooredoo font. The same rules apply to this as to the secondary typeface. Arial Italic is reserved purely to provide emphasis in body copy, or for captions to pictures.

5.3 Web fonts

Below are the principle typography details which help you set the font across the site.

Super Header | 30pt Ooredoo-Beta Bold

Header Header | 24pt Ooredoo-Beta Bold

TIME STAMPS | 16PT FUTURA HEAVY CAPITALS

Header | 16pt Futura Heavy on 18pt leading

Running Copy | 14pt Futura Medium on 20pt leading aecenas ultrices
lorem diam. Aliquam sollicitudin tristique nulla. Duis libero diam, con-
dimentum et, condimentum in, congue eu, tellus. Phasellus eu elit at nisi
ultrices lobortis.

Link | 14px Futura Heavy

Font sizes

Examples for headers
combined with different body
copy paragraphs.

Digital circle text box

- 6.1 Visual presentation
- 6.2 Variations of the digital circle text box
- 6.3 Colours and fonts usage
- 6.4 Appearance on digital platforms

6.1 Visual representation

Maximum length

Important

The maximum length of the device should be 22% (or less) of the image it's been placed on.



The following page discusses the clear space rule around the text and the device. The right amount of circles will keep enough brand identity without over crowding the spotlight.

Clear space

Text clear space

Halfline of the circle element indicates the beginning of the text or paragraph.

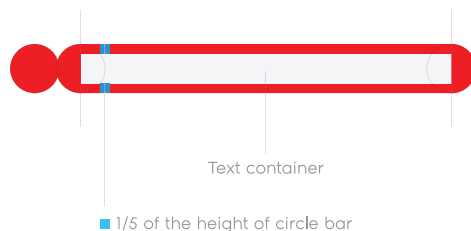

Device clear space

One unit space around the Circle Bar Device isolates the device and creates clarity to the paragraph and the CTA.

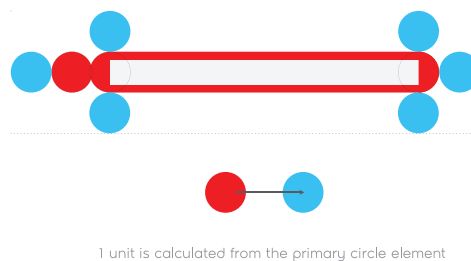

Avoid using

Avoid over using decorative circles. This will distract the users eyes by unnecessary elements and will take away from the clarity of the headlines, texts, and CTAs.



6.1 Visual representation

The digital circle text box is inspired by the Ooredoo logo. It is one of the assets of Ooredoo's identity that makes everything come from the same brand. It brings a scale of graphical opportunities when using text on large images whether on spotlights in homepages and inners pages. It responds and adapts to the online environment and responsiveness of devices.

The Digital Circle Text Box give enough brand identity to the website without being over decorative and crowded. It also isolates and gives clarity to the headlines and text.

It is the online version of Ooredoo's offline circle text box. Used on homepage and inner pages spotlights and banners. Acts as a frame when using headlines on large images. The digital circle text box is a flexible component that:

- 1- Adapts well to the length of the text whilst keeping enough real estate for the image itself.
- 2- Adapts to the device on which the user is browsing the website by automatically removing or adding circles depending on the screen size.
- 3- Adapts to the screen resolution by giving enough real estate to the image whilst keeping enough brand identity.

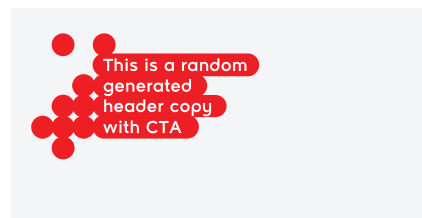

The digital circle text box on a website spotlight:
Shows how it adapts to the length of the text.

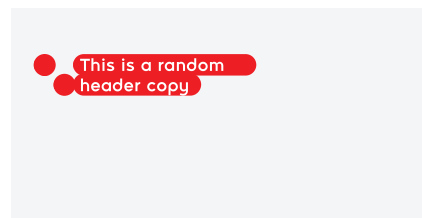

The digital circle text box on tablet
Shows how it adapts to different devices by removing some decorative dots to make it less crowded.

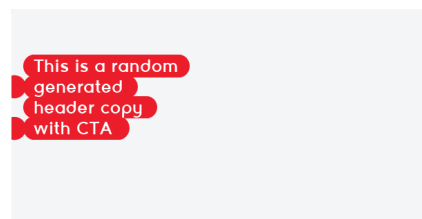

The digital circle text box on mobile
Shows how it adapts to the screen resolution to give enough real estate for the image.

6.2 Variations of the digital circle text box

To obtain a consistency throughout the markets and group websites, some simple rules of build and design apply.

Digital circle text box with maximum (4) bar set



Digital circle text box with the maximum (4) bar set and maximum bar width.



Digital circle text box with a maximum (4) bar set and bar width variations.

Special Digital circle text box with maximum (4) bar set



Special Digital circle text box with a maximum (4) bar set and extended top area.



Digital circle text box with a maximum (4) bar set and bar width variations

Digital circle text box with a (3) bar set



Digital circle text box with a three bar set and maximum bar width.



Digital circle text box with a three bar set and bar width variations.

Digital circle text box with 1 & 2 bar sets



Digital circle text box with a two bar set and bar width variations.



Digital circle text box with a single bar set.

6.3 Colours and fonts usage

Device colours

<p><u>Ooredoo Red</u></p>  <p>R: 237 G: 28 B: 36 Hex: ED1C24</p>	<p><u>Ooredoo Dark Grey</u></p>  <p>R: 90 G: 90 B: 90 Hex: 5A5A5A</p>	<p><u>Ooredoo Light Grey</u></p>  <p>R: 209 G: 210 B: 211 Hex: #D1D3D4</p>	<p><u>Pure White</u></p>  <p>R: 255 G: 255 B: 255 Hex: FFFFFFFF</p>
---	--	---	--

Colour rules

The two only variations for the circle bar device are:

- 1 - Red background, white text
- 2 - White background, dark grey text

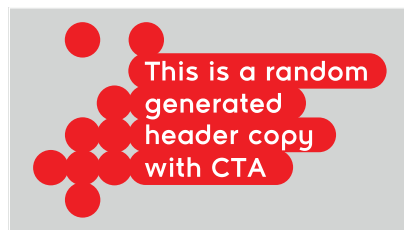

White copy on red device

Font usage in digital circle text box

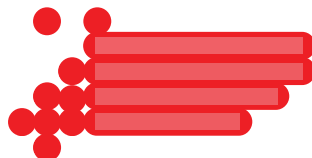

Ooredoo Regular/Bold - Font Family

ABCDEFGHIJKLMNOPQRSTUVWXYZ

abcdefghijklmnopqrstuvwxyz

0123456789

Fonts

The font to be used inside the circle bar device is the custom Ooredoo font.

6.1 Appearance on digital platforms

The circle bar device adapts to the device environment it is used on. The following page showcases the behavior of the circle bar device on different devices, desktop, tablet, and mobile.



Spotlight image

Appearance on website

The circle bar device can be seen in its totality. Because there is more real estate, the designer can choose to work the designs with the "special circle bar device", adding more circles on the top.



Appearance on tablet

On tablet and for better visibility of the spotlight, the circle bar device will reposition as shown in the image on the left.

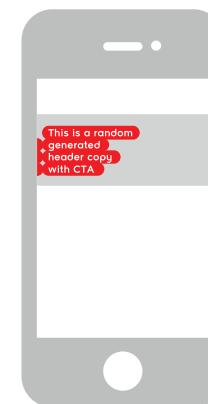

Appearance on mobile

On mobile and for better visibility of the spotlight, the circle bar device will reposition as shown in the image on the left. This is the minimum value for the -X- coordinate. To keep enough brand identity and to preserve the circle text box, designers should not move the circle grid behind this point.

Websites and Apps

Grid system

- 7.1 Overview
- 7.2 Website grid system
- 7.3 Grid variations #1
- 7.4 Grid variations #2
- 7.5 Mobile grid
- 7.6 Tablet grid

Using grids are fairly useful in web design.

They help designers to structure the page visually and are quite practical for developers who build templates and stylesheets.

Do this by providing cross-browser-tested and optimized preset column widths for you to set your content into.

7.2 Website grid system

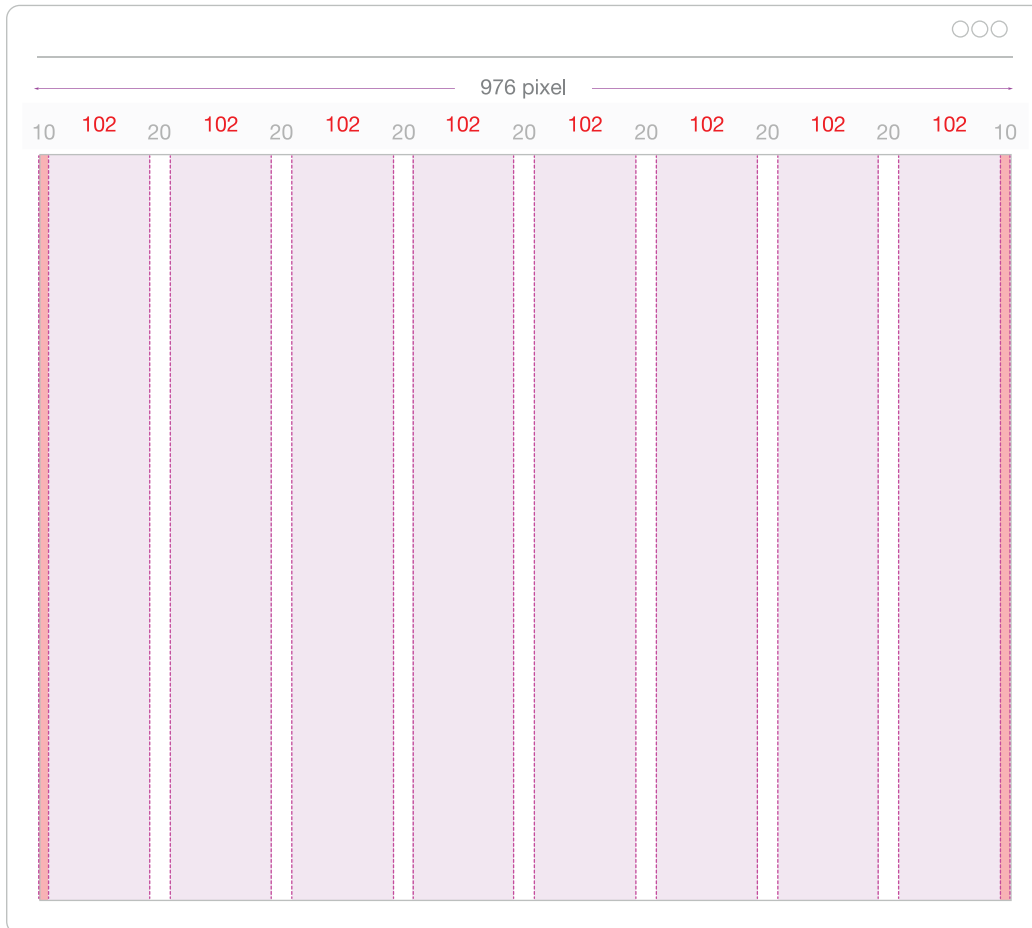

976px grid system

All page templates are preferably built using a 976px grid. This universal grid allows us to create flexible arrangements and convenient clear space around any content. Breaking the grid should be justified. Our grid is 102px-based, 8-column system. The left and right gutters are 10px.

7.3 Variations #1

Columns can be further divided. The grid allows for a huge range of experimental layouts and templates.

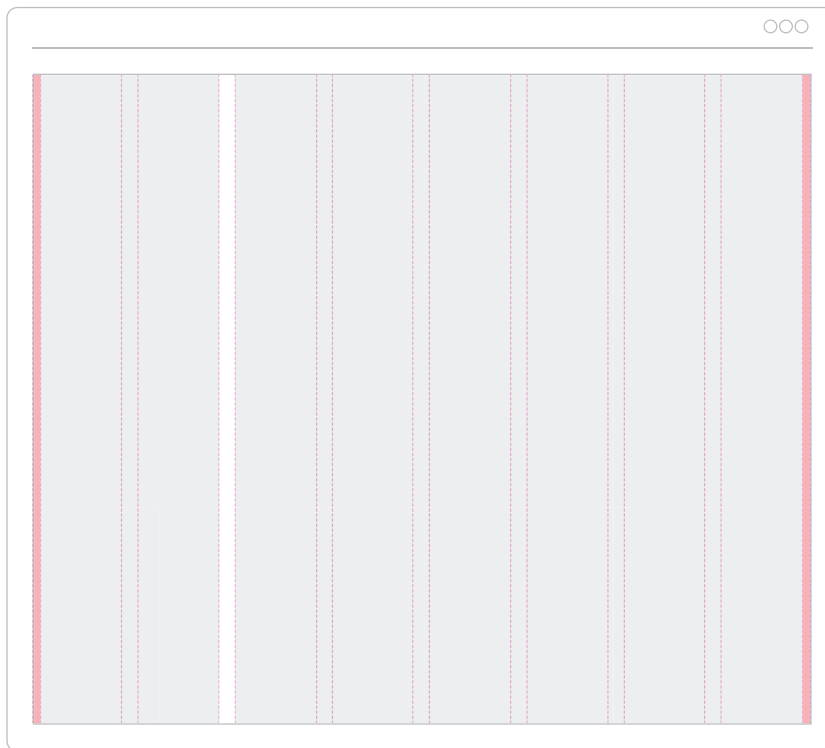

Layout Option 1

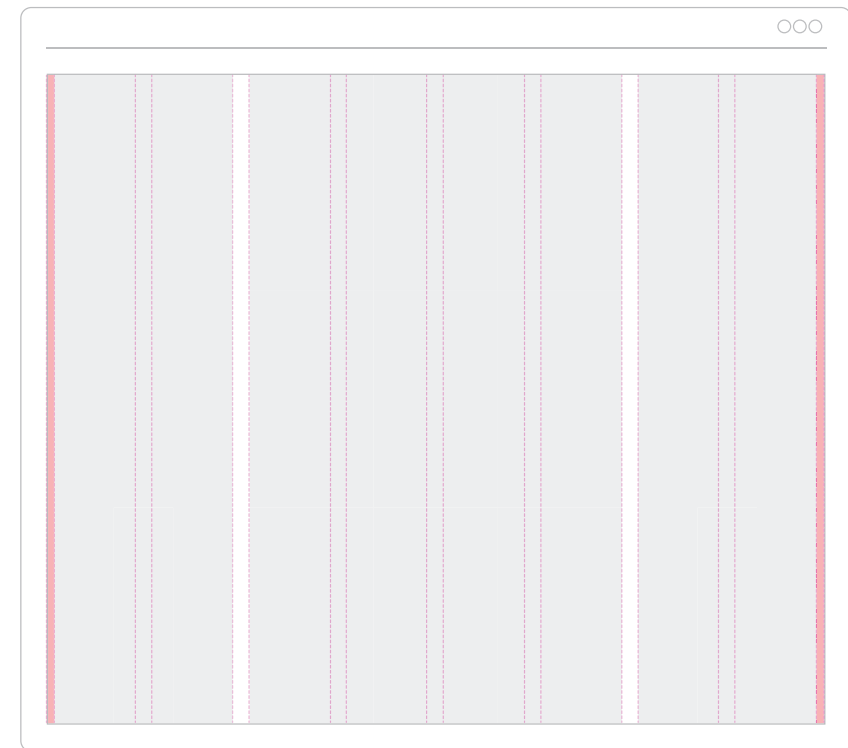

Layout Option 2

7.4 Variations #2

Columns can be further divided. The grid allows for a huge range of experimental layouts and templates.

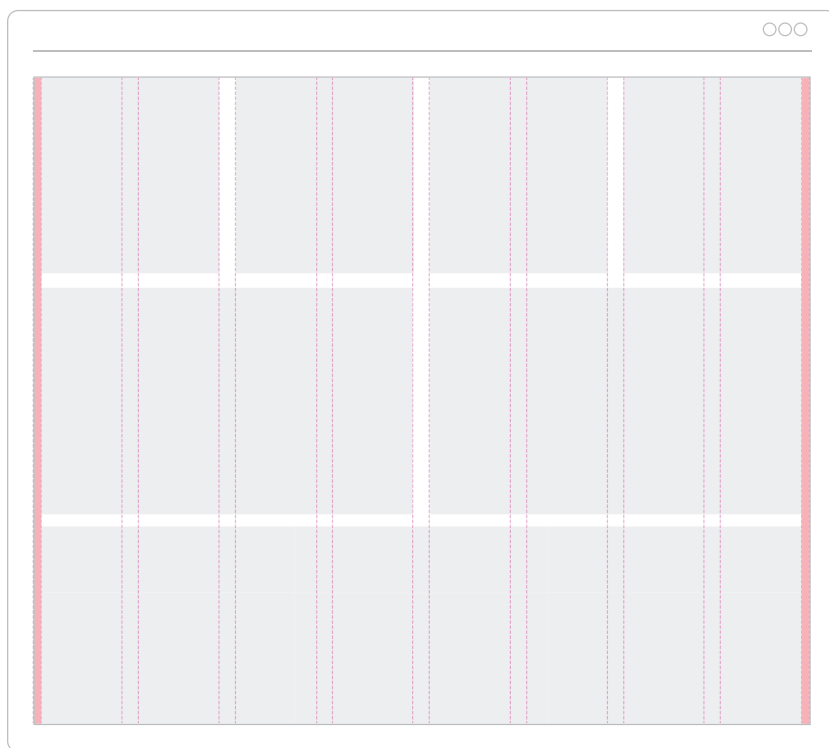

Layout Option 3

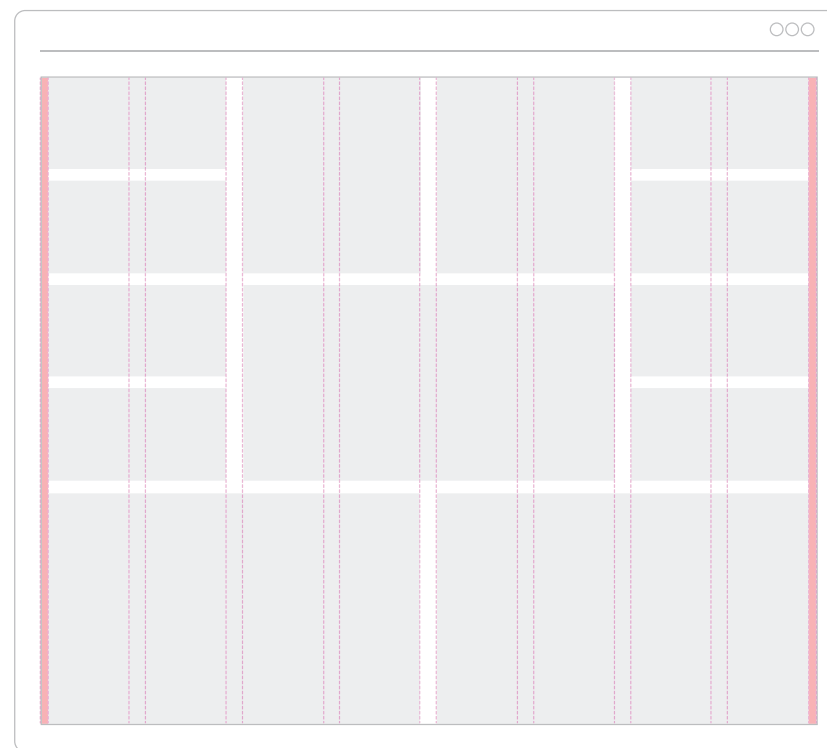

Layout Option 4

7.5 Mobile grid system

Responsive Web design is the approach that suggests that design and development should respond to the user's behavior and environment based on screen size, platform and orientation. The practice consists of a mix of flexible grids and layouts, images and an intelligent use of CSS media queries.

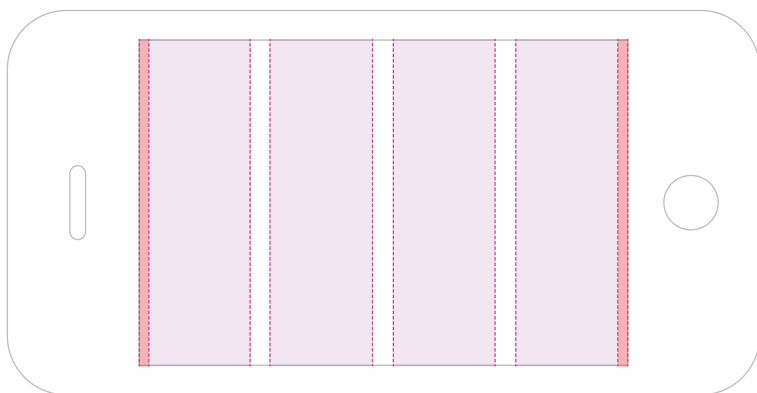

4 column layout

Horizontal grid template

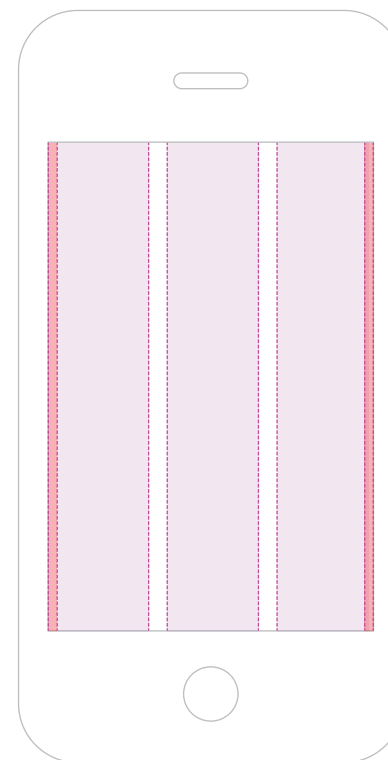

3 column layout

Vertical grid template

7.6 Tablet grid system

The website should have the technology to automatically respond to the user's preferences. This would eliminate the need for a different design and development phase for each new mobile device on the market.

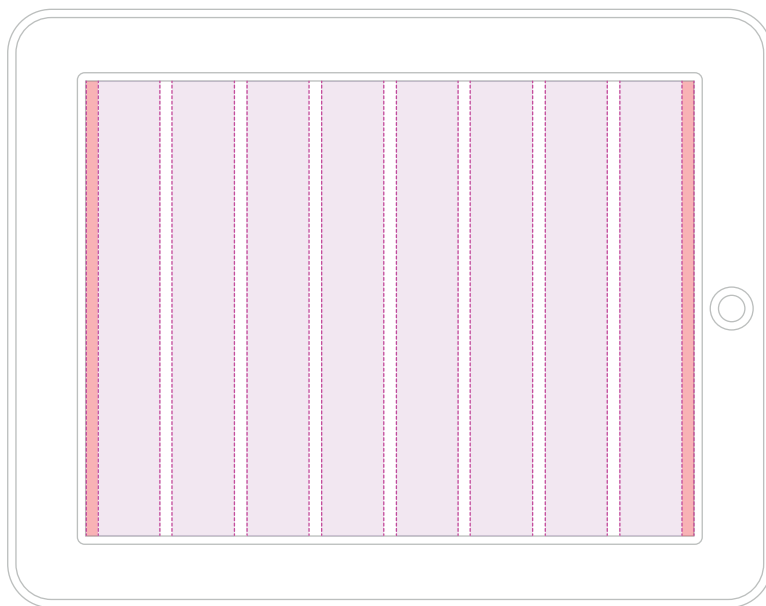

8 column layout

Horizontal grid template

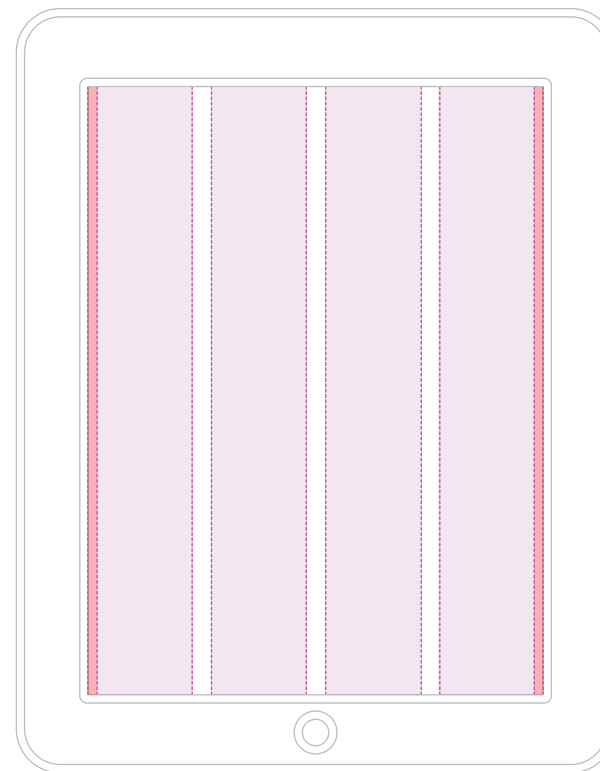

4 column layout

Vertical grid template

Website

- 8.1 Brandmark build-up
- 8.2 Where to use the logo?
- 8.3 Logo misuse on websites
- 8.4 Global masthead
- 8.5 Header
- 8.6 Dropdown menu
- 8.7 Spotlight widget
- 8.8 Spotlight function
- 8.9 Footer
- 8.10 Call to action
- 8.11 Favicon
- 8.12 Sign-in box

8.1 Brandmark build-up

The circle grid (brandmark) is built up from the circles of the logo. An overlap of $1/10$ X. It can be used in shades of grey. The created pattern keeps consistency with the brand a ties up all the website across the market.



Tile pattern

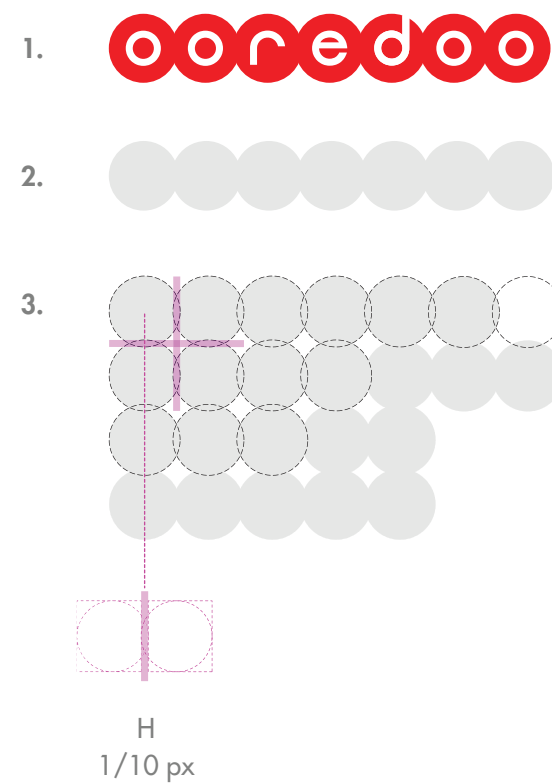

8.2 Where to use the logo ?

There are two versions of the logo, one horizontal and one stacked, which are shown below. The stacked logo should only be used in social media or mobile applications where the standard logo does not work because of size or format restrictions. The **Ooredoo** logo is always red.

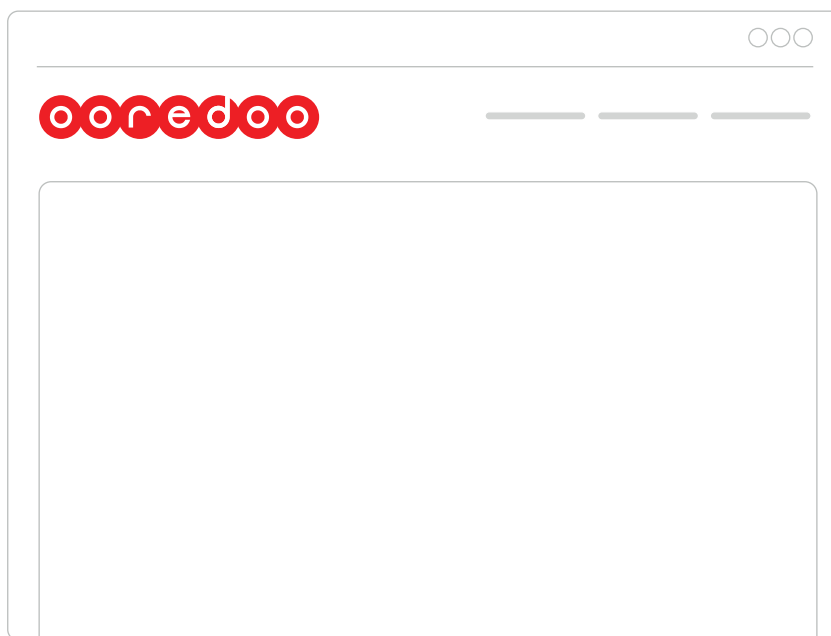

Example of the
Horizontal logo usage on a website.

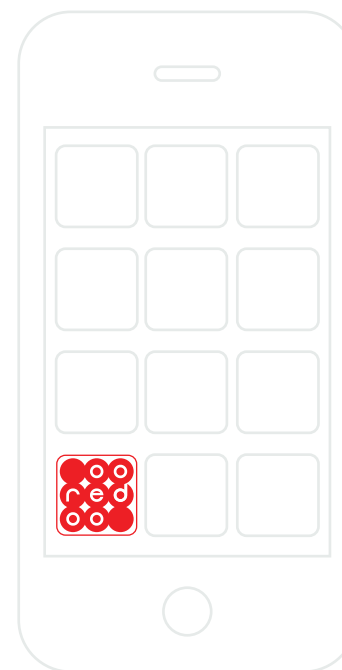

Example of the
Stacked logo usage on a mobile app

8.2 Logo misuse in websites

Always follow the logo placement and display standards presented in this Digital Brand Guidelines. The examples on this page illustrate some of the acceptable and unacceptable uses of the **Ooredoo** logo.

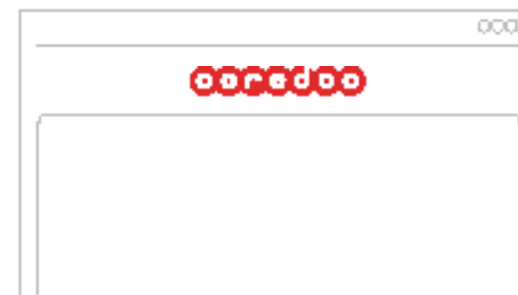
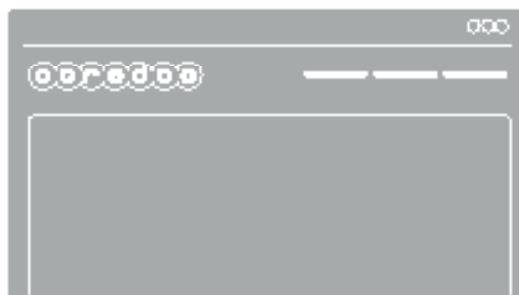
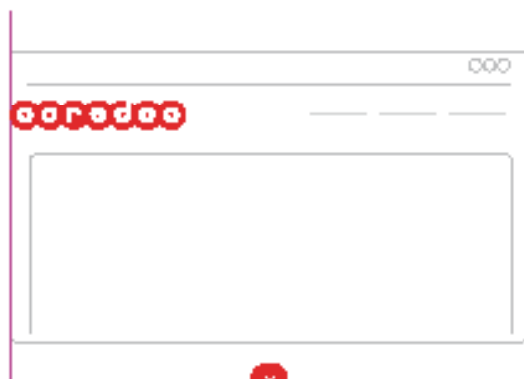
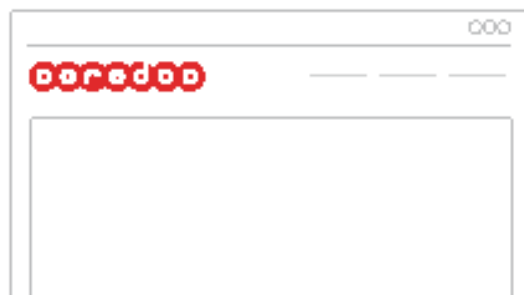

8.4 Global masthead

The masthead should contain the global navigation on all **Ooredoo** web sites including: Top left navigation, language selector, signup, country and the login. The build-up is shown below.

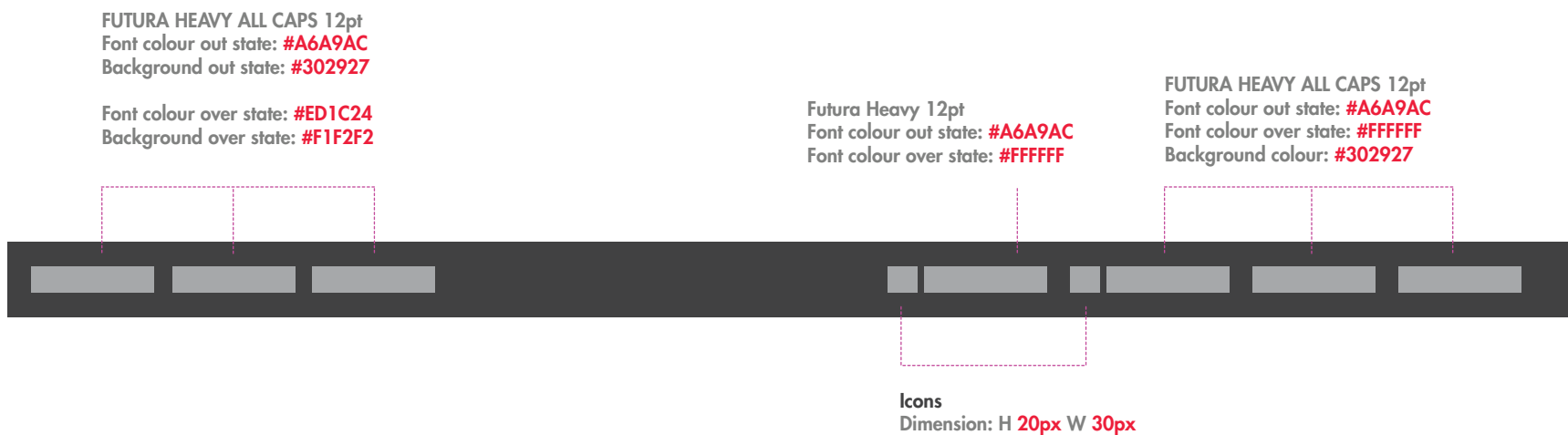

Global masthead

8.5 Header

You must create a universal header strip which is easy to navigate and stands out with our vibrant Ooredoo red background. The Futura typeface gives a clear and organized look and feel.

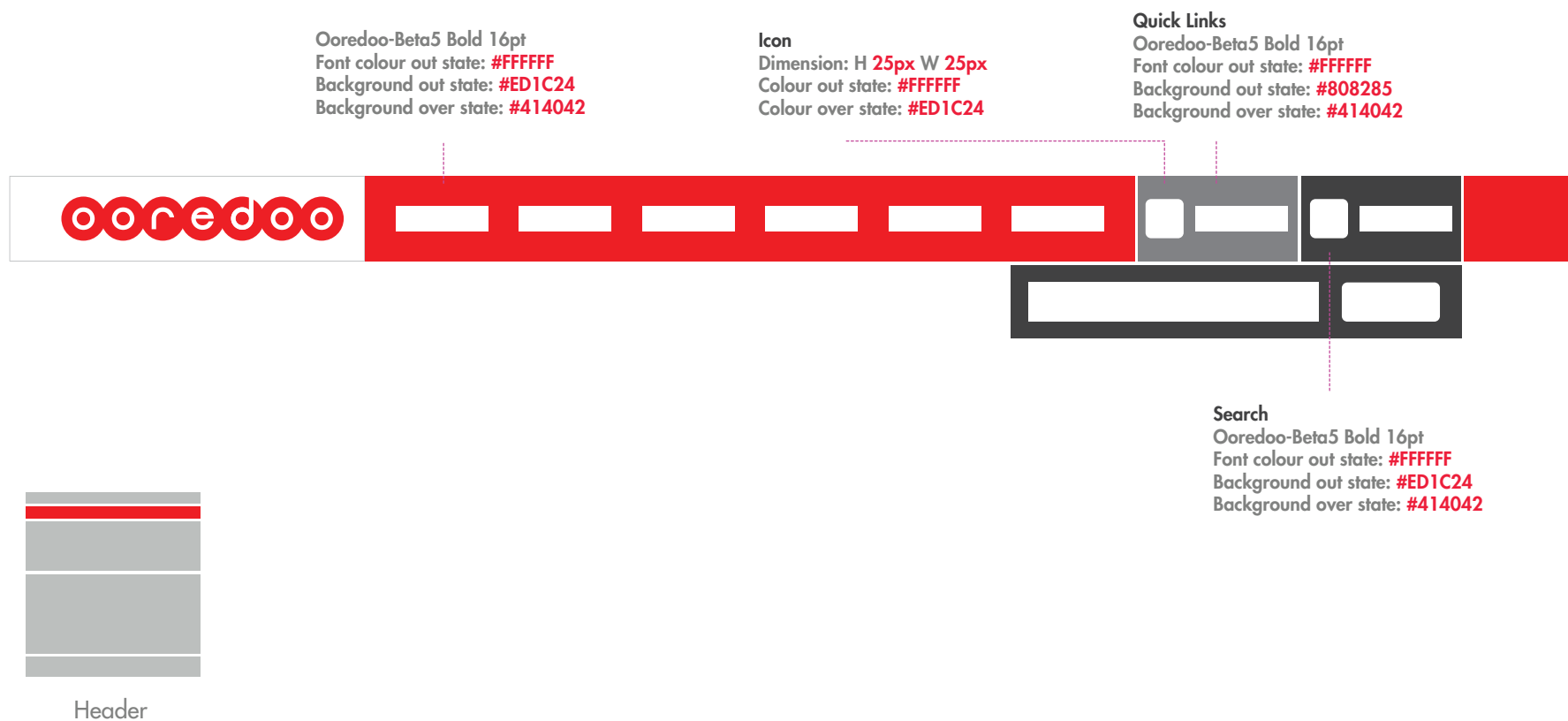

8.6 Dropdown menu

Ooredoo dropdown menu is a hybrid device. It allows us to use text and image based navigation elements if necessary and if the content requires it. The menu content could be text only or text and image (mixed). The dropdown dimension is dynamic and expandable; however the content defines its height.

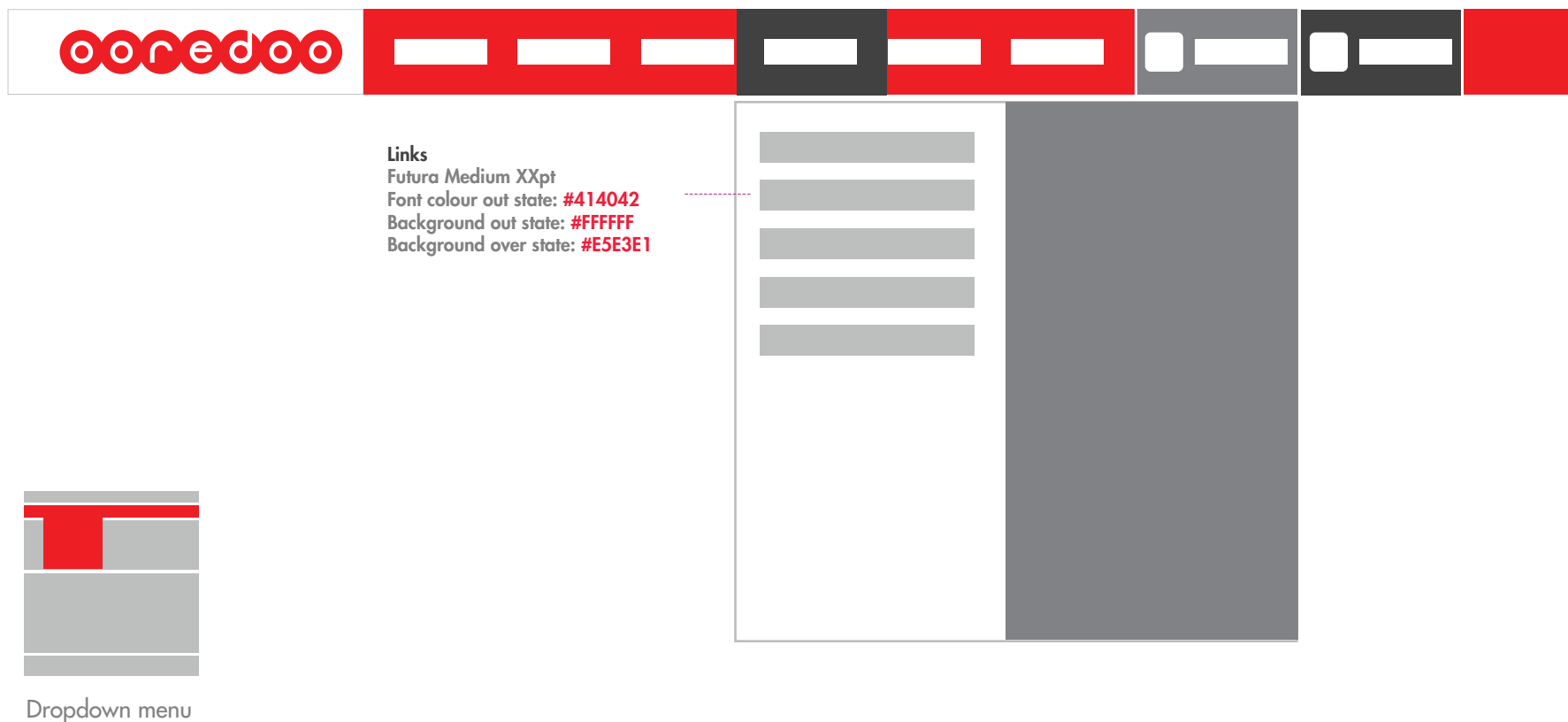

8.7 Spotlight widget

The spotlight is located below the header. This area is where the website advertise or showcase the important content that the website has. It makes the page visually rich. Leverage content from different section of the website and allow user to click through these sections.

Homepage spotlight

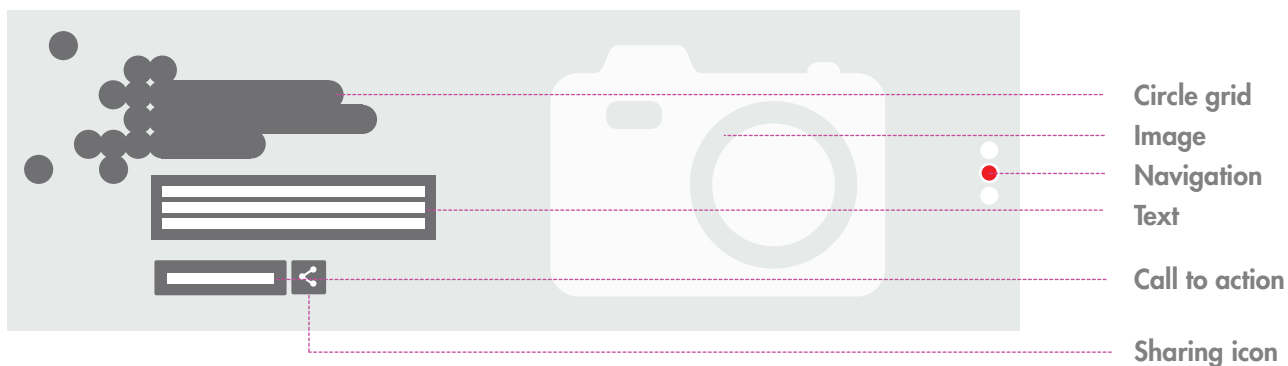

Dimension

The dimension of the spotlight is fluid. It automatically adjusts depending on the resolution of your screen.

Spotlight image retouching

Keep in mind that when you use a photo as a spotlight visual, always make sure that it follows the photography guideline and does not affect the circle grid in any way.

Section spotlight

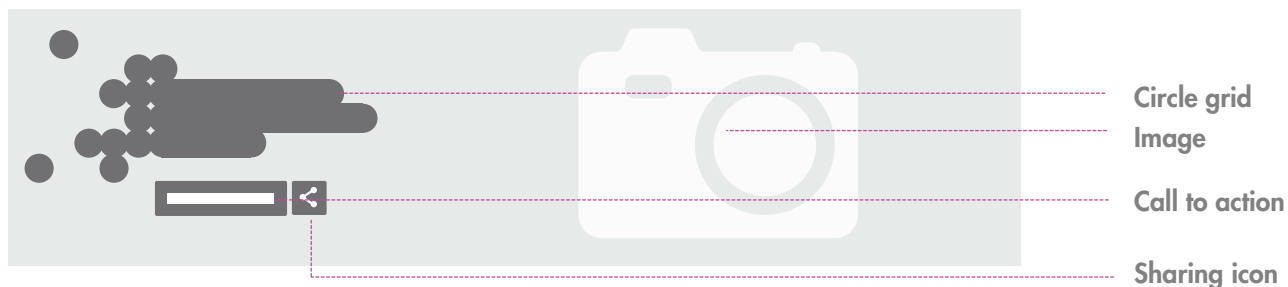

8.8 Spotlight function

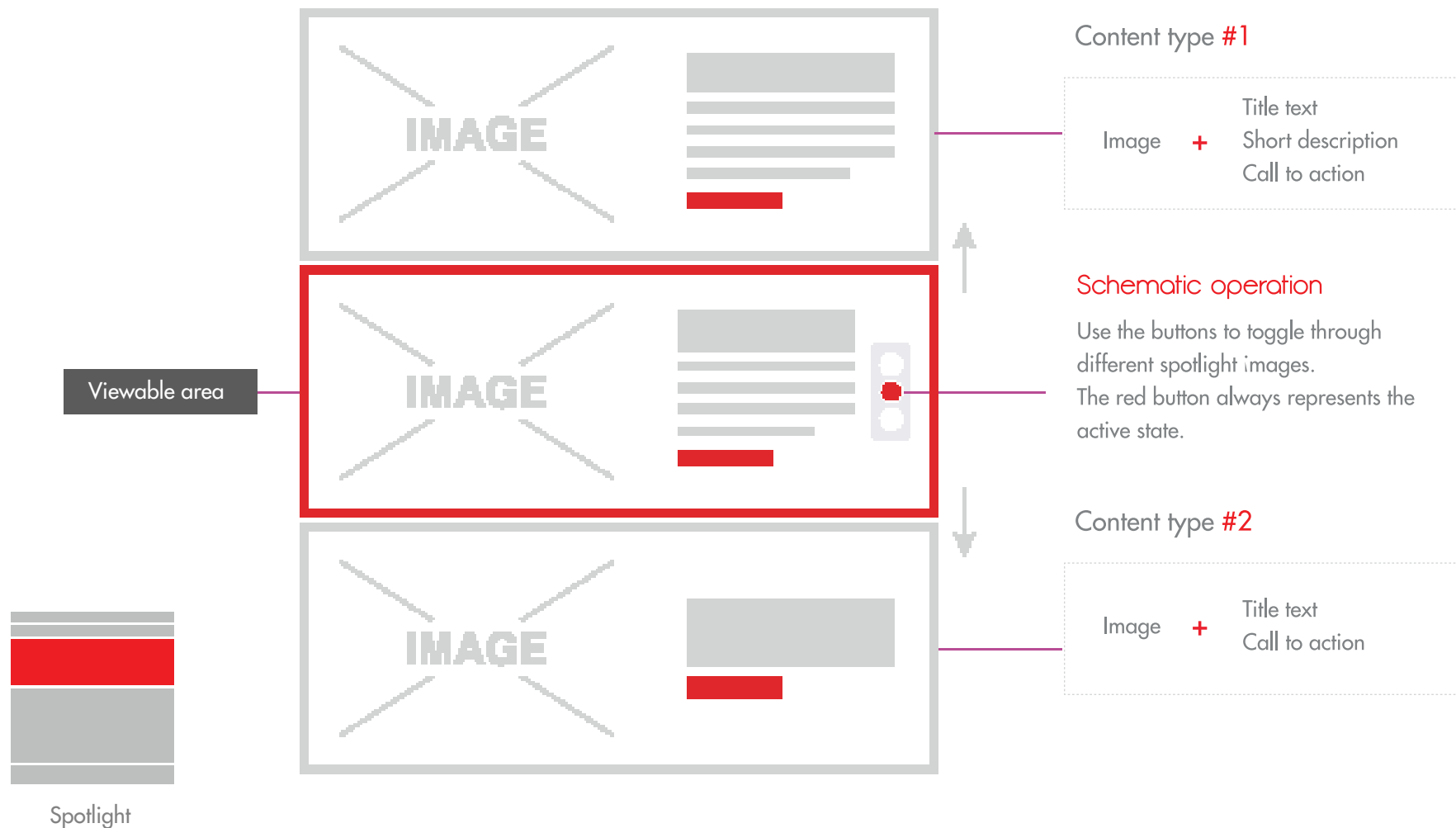

8.9 Footer

Our footer should be an expandable. This user interface pattern allows the user to reveal hidden footer regions by clicking the show button if they wish to see more content. This function is very similar to the accordion effect.

Futura Heavy 11pt
Font colour out state: #FFFFFF
Font colour in state: #E6E7E8

FUTURA HEAVY ALL CAPS 18PT
Font colour: #E5E3E7

Social media icons

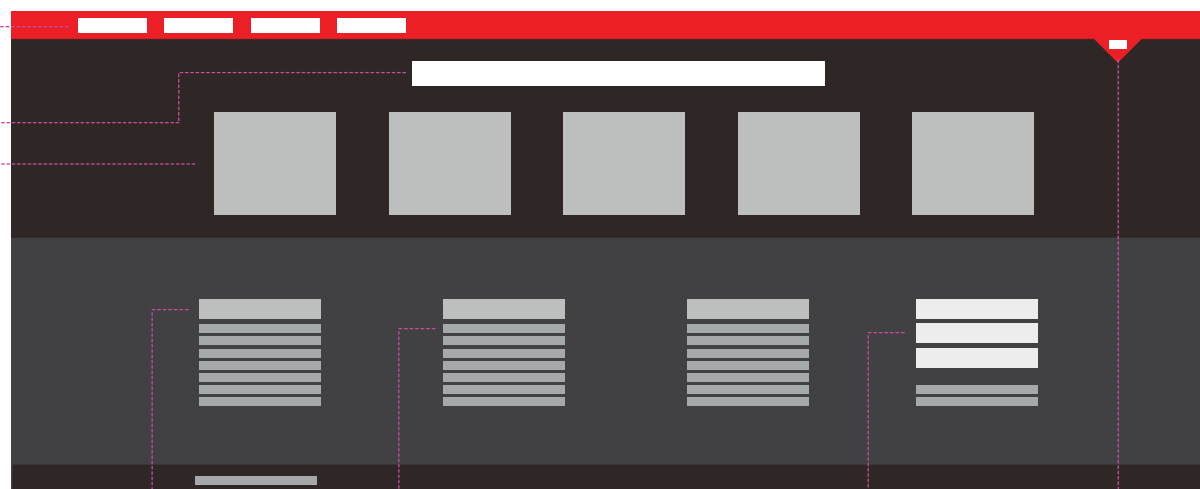

FUTURA HEAVY ALL CAPS 14PT
Font colour: #E5E3E1

Futura Medium 14pt
Font colour: #BFBAB8

Futura Heavy 14pt
Font colour: #E5E0DD

Expand/Hide call to action
Futura Heavy 11pt
Font colour out state: #FFFFFF
Font colour in state: #E6E7E8



Footer

8.10 Call to action

To keep the consistency throughout Ooredoo's market websites, consistency in call to actions is required. How a call to action is displayed, what colour does it use, what font does it have, what its minimum size, its behaviour state, all these questions need to be answered when designing a button.

Background Colour

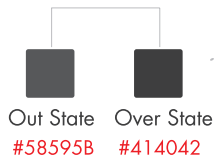
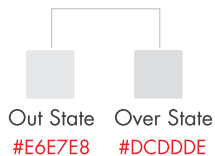
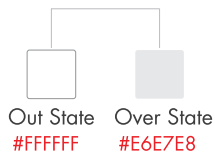
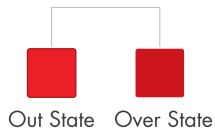

Stroke Colour

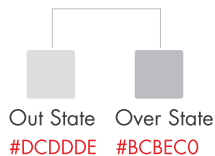
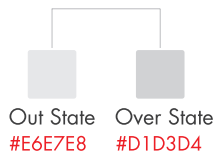
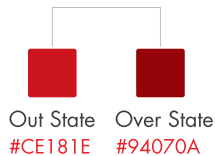

Text Colour

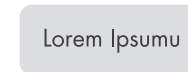
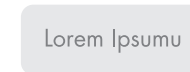
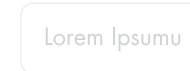
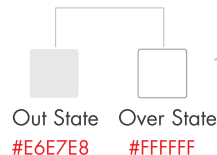
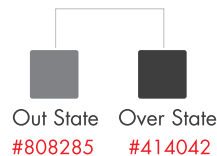
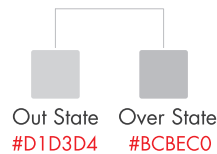
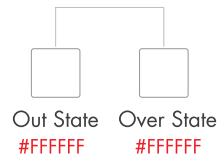

8.11 Favicon

This little icon is a part of the overall **Ooredoo** branding strategy. It helps to identify the web site and the red colour makes it stand out in any web browser when multiple tabs are opened.

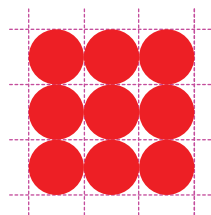

Favicon grid

The regular favicon size is 16 x 16px. **Ooredoo** favicon was created by 9 red stacked circles. Each circle is 5 x 5 px.

Unlike the original stacked logo where circles intersect, the favicon circles should not intersect, to have more white space.

To avoid the stacked logo looking blurry and pixelated we removed all the characters from the brandmark keeping only the red circles, therefore the grid becomes a sharp and crisp visual representation of the **Ooredoo** logo even in tiny size.

Example of the original stacked logo with text and where circles intersect.

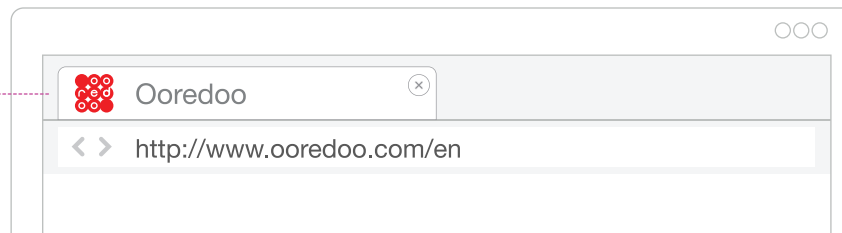
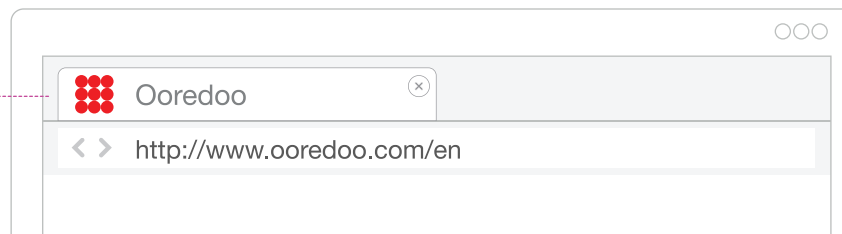

8.12 Sign-in box

The sign-in box is the gate to the website. It should have all elements which enable the user to sign-in. Need to appear globally on all website pages if the user is pre-logged in (and available).



Iconography

Iconography categories

- 9.1 User interface and navigation icons
- 9.2 Services, products, and features icons
- 9.3 Illustrations

Strong and vibrant iconography consistency needs to apply throughout all the Ooredoo markets and digital applications. One way of achieving that is by following the same principles of categorisation.

9.1 User interface and navigation icons

User interface and navigation icons represent a program or command, file, directory or device.

These icons are used across the Ooredoo digital scope, enhance the user experience and point users in the right, consistent direction when they want to undertake an action.

These icons are:

- Most seen and present on Ooredoo online applications.
- They are universal in understanding and function - crossing language and geographical barriers.
- Always following the same design principles.

Example of user interface & navigation icons:

Register, share, stop, print, connect ,next, previous, social network icons etc...

Example of user interface and navigation icons used below, clearly shows how these icons can be used on a small scale and how they convey meaning and sign post key user journeys.



9.2 Services, products and features icons

The services/products icons and the features icons don't have the same function to the user, however we put them in the same category because they follow the same design principles.

Services and products icons

Represent any Ooredoo product, service or application. These icons are simple and bright. They draw the attention to a certain service or product that Ooredoo is offering. They add up with time, need to be different, and stand out one from the other.

Example of features icons

Are icons that act as an extra thin layer that illustrate a word or a text. They add life to a text, make information more pleasant to read and create a friendly overall environment. They enhance the overall user experience.

These icons :

- Are visually richer and more flexible in terms of colours.
- Provide with interface and navigation information.
- Add visual interest and beauty to the brand.
- Leverage the product, service or application.
- Leverage the text or copy they represent.

9.2 Services, products and features icons

Example of services and products icons

Clearly demonstrates how these services and products belonging to the same brand are different one from the other but are still consistent in terms of design.



Example of Features icons

Clearly demonstrates how sometimes an extra illustrative layer can add life to a text and make it more pleasant to read.

The thought and consideration we put into our products go well beyond design.

Google

Calendar
Organize your schedule and share events with friends

With Google's free online calendar, it's easy to keep track of life's important events all in one place.

- 31** **Share your schedule**
Let your family and friends see your calendar, and view schedules that others have shared with you.
- Get your calendar on the go**
Access your calendar from your phone using its built-in calendar or mobile browser.
- Never forget another event**
Get event reminders via email or have text messages sent right to your mobile phone.

How a product looks and performs matters, but so does its impact on the environment. That's why nearly every Apple product is made from highly recyclable materials like aluminum, and why we refuse to use harmful toxins in our components.

Every iPhone starting with iPhone 3GS is free of brominated flame retardants (BFRs) and polyvinyl chloride (PVC). That includes our newest iPhone — iPhone 5. In fact, Apple has one of the strictest BFR-free and PVC-free standards in the industry. And we expect the same from our suppliers. We go so far as to disassemble our products into individual components and materials in our Cupertino lab. Then we test them using many methods, including X-ray fluorescence spectroscopy and ion chromatography. We do this to ensure that every product we release meets our environmental standards.

To learn more about Apple's dedication to reducing the environmental impact of our products and processes, visit the [Apple and the Environment website](#).

9.3 Illustrations

Ooredoo is socially involved and present in many different markets & countries. The objective is to provide with a unified design and graphic style which can be used for any digital activities. The illustrations have to obey certain design principles and guidelines.

The illustrations:

- Are complex but can be simple in appearance.
- Can be a story, an animation, or an illustrated campaign etc.

Illustrations: The below illustrations have been created for Google. We can clearly see that they illustrate different themes and convey different atmospheres while still following the same principles in design.

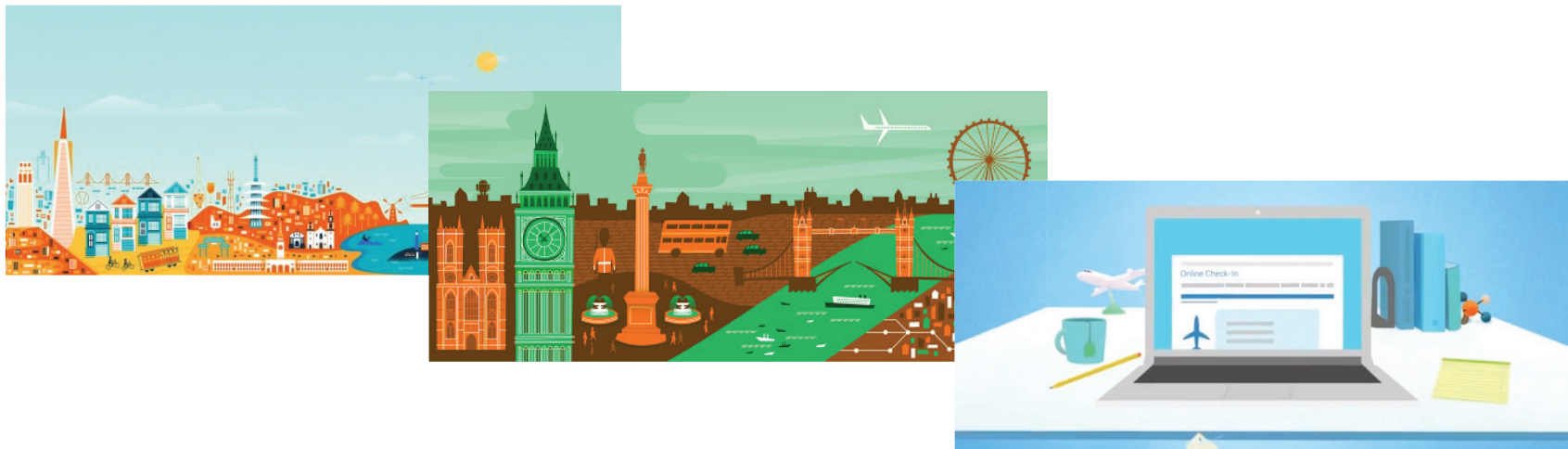

Iconography design principles

- 10.1 Pixel perfect iconography
- 10.2 Skeuomorphic flat design
- 10.3 Geometrical shapes
- 10.4 Icon grid
- 10.5 Perspective
- 10.6 Rule of shading

To keep a strong and consistent visual iconography throughout the markets, each icon should be designed following certain design principles.

10.1 Pixel perfect iconography

No matter the resolution, no matter the device, Ooredoo iconography always displays perfectly.

The solution: Scalable Vector Graphics - SVG

SVG's are rendered as vectors and are therefore able to scale to whatever screen resolution they are being viewed on, whilst maintaining the sharpness and crystal quality intended when they were first designed.



10.2 Skeuomorphic flat design

Skeuomorphic design is a design that transpose real world object. Skeuomorphic flat design is a design that uses simple elements and shapes combined with predominantly bright colors to emphasize simplicity and clarity. When we refer to a skeuomorphic flat design we mean a more minimalistic yet realistic, two-dimensional approach. Skeuomorphic flat design tries to emphasize usability and simplicity providing an enhanced user experience.



Good to know!

Brands like Google, Apple & Windows that managed to create a strong channel identity consistent throughout all their channel create a strong balance between flat design and skeuomorphic design principles.



10.3 Geometrical shapes

Consistency in graphical style is important for a strong brand image. This is achieved by applying design rules such as designing icons with geometrical shapes. Also, it is an efficient way of designing a large number of icons. By using this method any designer will be able to create an icon that will have a shape consistency with all the other Ooredoo brand iconography.

Icon Build Example

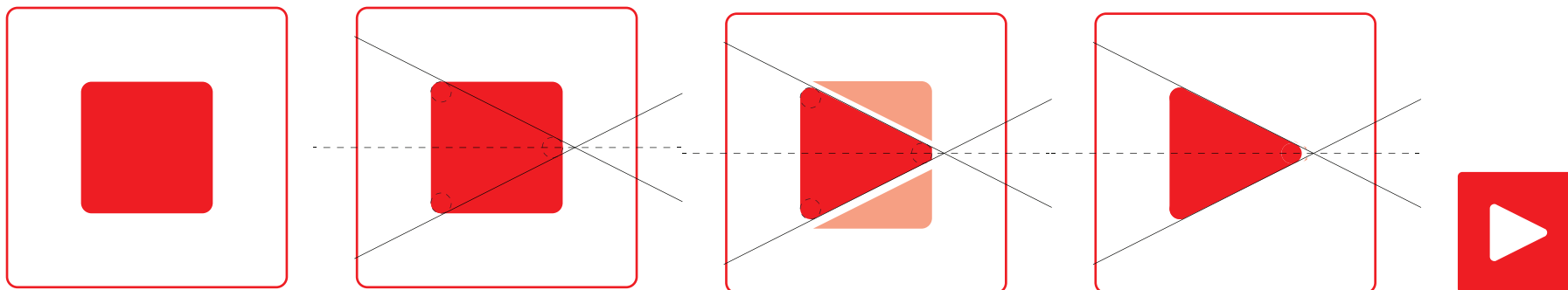

Good to know!

Twitter logo was built using geometrical shapes

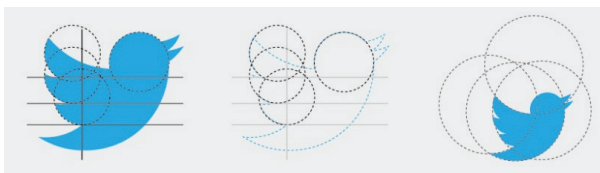

10.4 Icon grid: Limit and frame

To keep a visual consistency with the brand, Ooredoo's iconography is built following a defined grid system based on the circles of the stacked Ooredoo logo.

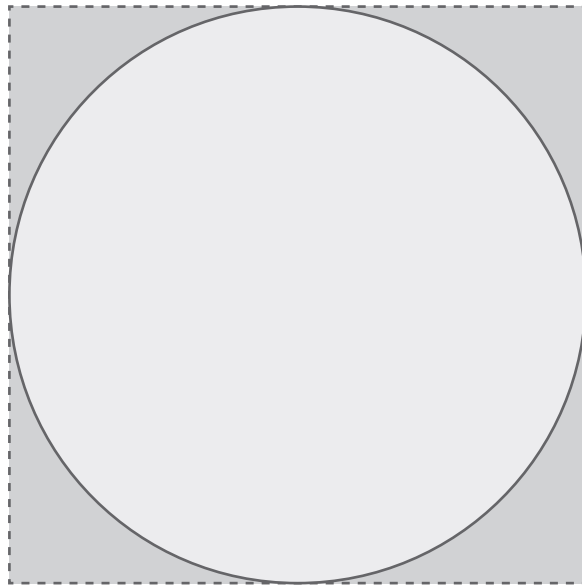

Step -1- Building the icon area

The above image shows the circle inside the 300 X 300px square. The circle will determine the icon area.

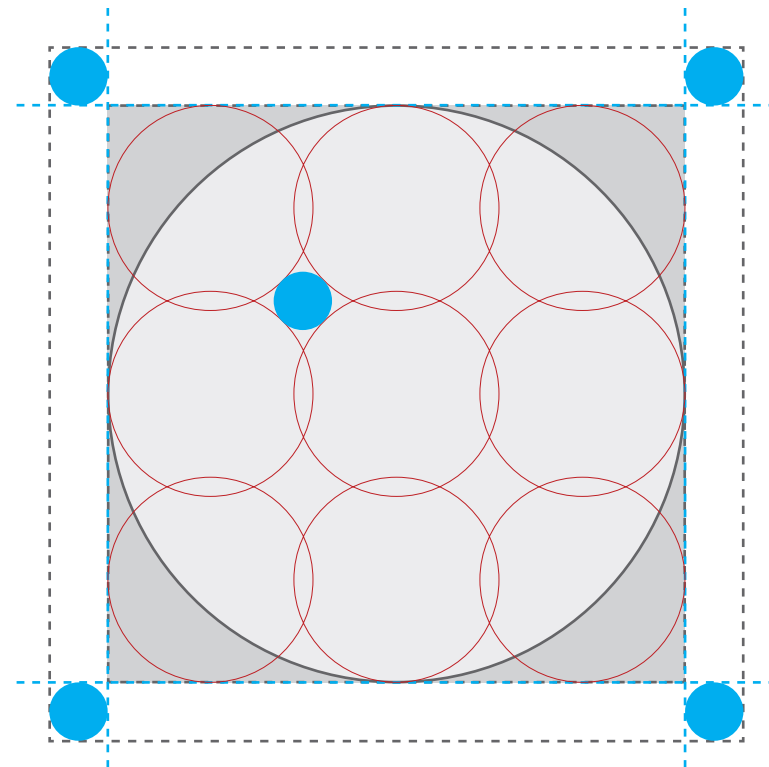

Step -2- Building the icon breathing space

The stacked Ooredoo logo sits inside the square. The blue circle is a measure reference for the iconography build. It is determined by the 4 tangent to the 4 Ooredoo logo circles (as shown above). The circle determines the icon breathing space.

10.4 Icon grid: Reference points

For all icons to have common strong key and reference point, Ooredoo icons has it unique grid system shown below.

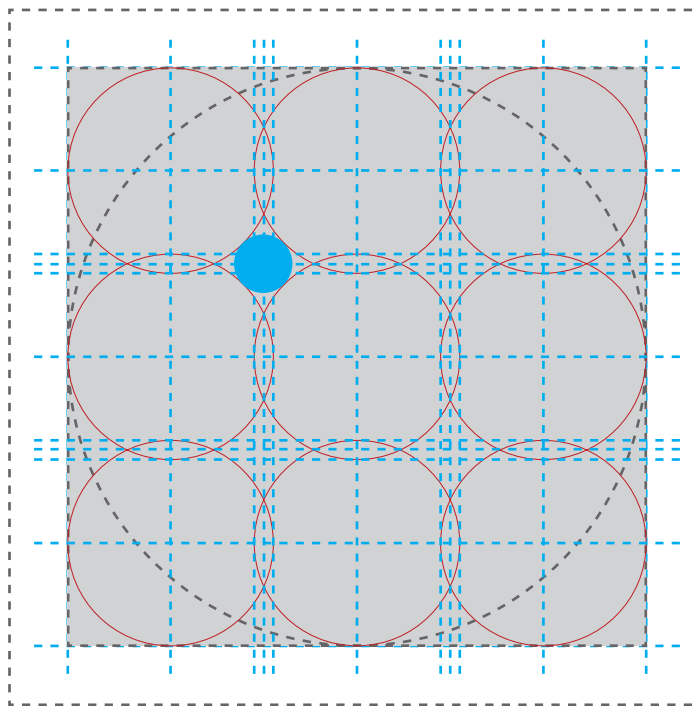

Step -3- Building the icon grid

By drawing the lines as shown in this image we determine intersecting key points.

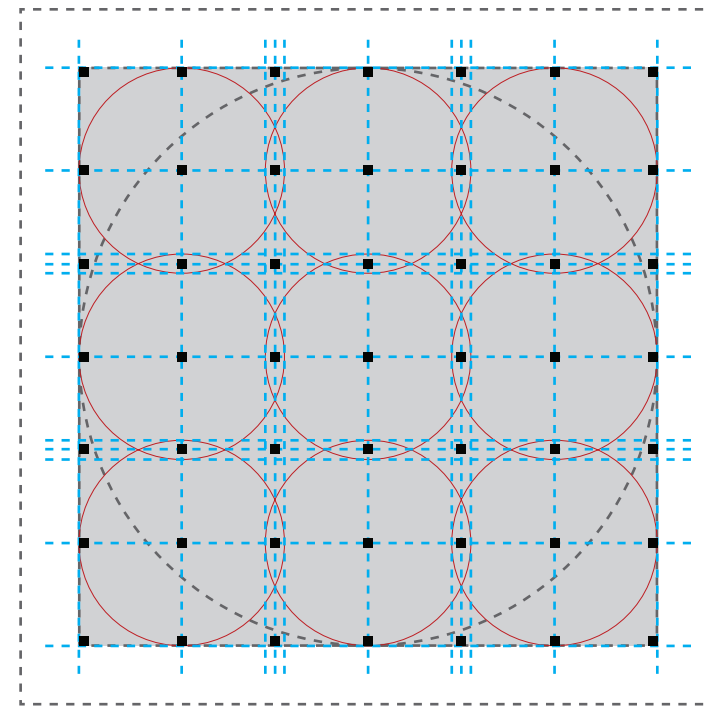

Step -4- Highlighting the grid key points

All the intersections are highlighted by a black dot. They will serve as key points and reference for the Ooredoo iconography grid.

10.4 Icon grid: Guide

Below is the Ooredoo icon grid and breathing space.

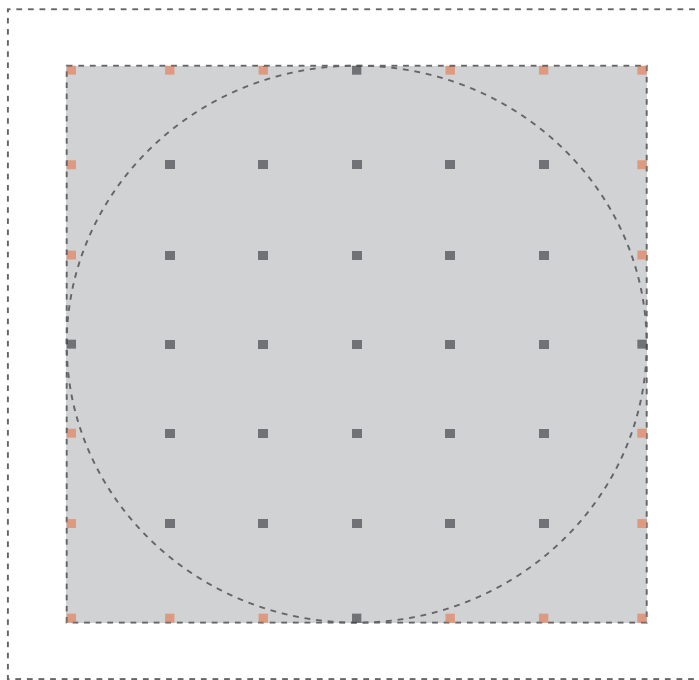

Icon full grid

The grid helps shaping the icon. The defined dots are a reference for the directions of the lines, the angle between two lines, and the edges of the icon etc.

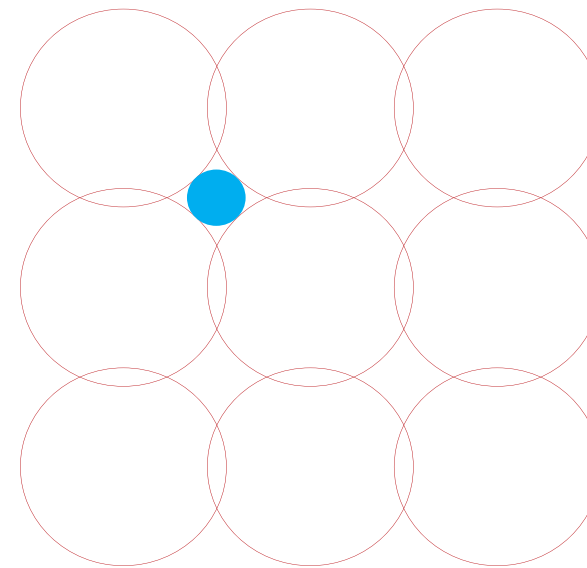

The blue circle:

- Determines the breathing space around the icon.
- Is a reference for line and icon thickness.
- Is a reference when rounding the edges.

10.5 Perspective

To strengthen our flat design approach, all Ooredoo icons should be designed using the front view perspective. This will maintain a visual consistency for all the icons throughout all the markets and throughout all the digital spectrum of Ooredoo.

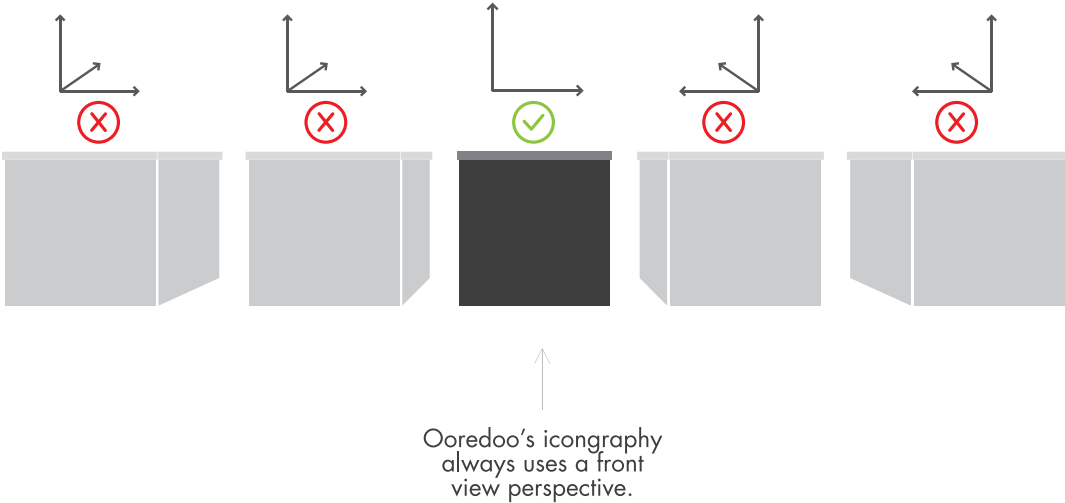

10.6 Rule of shading

To keep consistency with the offline brand guidelines, Ooredoo’s iconography does not use any kind of shading, drop shadows or gradients.

Use flat colour always.

Don't use straight, hard, gradient or drop shadows shadings.

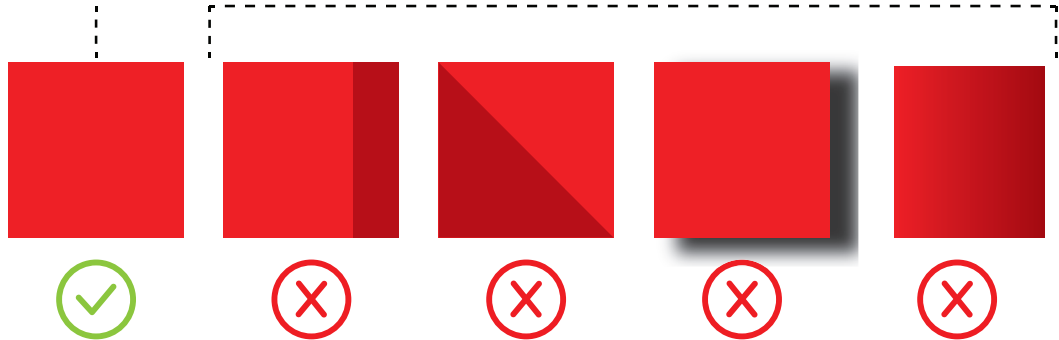

Good to know!

Most of Philippe Guluck drawing of “Le chat” don’t have shadows. It is a coloring choice and consistency that the illustrator chose and that assure a consistency in his work.



Iconography' colours and backgrounds

- 11.1 Ooredoo colour palette
- 11.2 Colour rules
- 11.3 Colour codes
- 11.4 Icon Backgrounds

The use of colours in a consistent way for each category will help strengthen the brand visual identity online. Each category has its own do's and don'ts when it comes to colouring and background.

11.1 Ooredoo's colour palette: Primary colours

Below is the primary colours palette with the spectrum of shades. The user interface and navigation icons are always built using the primary colours only. Services, products and features icons are built using the whole primary spectrum colours. It will strengthen the brand image and will keep a consistency throughout the Ooredoo digital space.

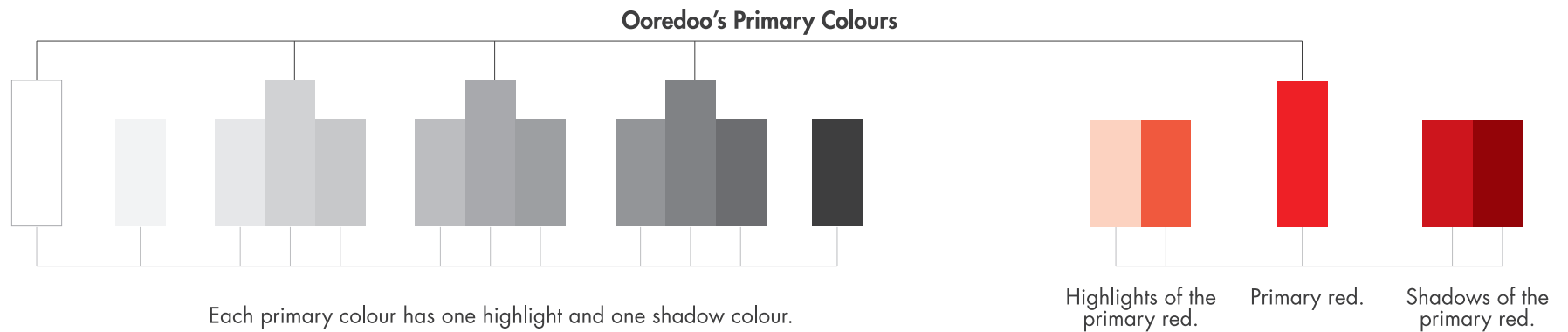

11.2 Ooredoo's colour palette: Secondary colours

Bright and rich these colours create a friendly atmosphere when used. These colours are only used when designing and creating illustrations.

These colors are taken from the offline brand book of Ooredoo

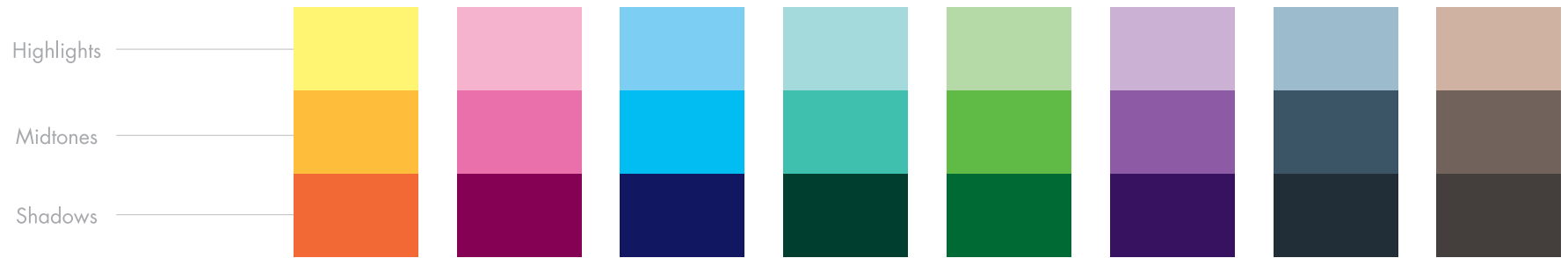

11.2 Colour rules: User interface and navigation icons

Depending on their application, the user interface and navigation icons always:

- Use one primary colour.
- Use only the colours below.

Ooredoo's user interface and navigation icons can only be used in the below colours.

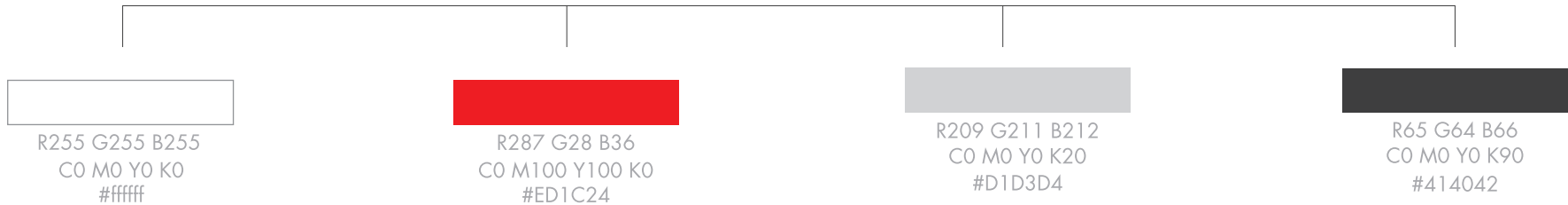

11.2 Colour rules: Services, products, and features icons

Services, products, and features icons uses the 2 colours combination rules.

The two colour combination rule:

The highlight, midtone and shadow of one colour (red in this case) are considered one colour. They can mix together, they can mix with another colour (including it highlights, midtones and shadows).

In Ooredoo's case, reds can be mixed together and form an icon. Greys can be mixed together in one icon. Reds (highlights, midtones & shadows) and greys (highlights, midtones & shadows) can be mixed together in one icon.

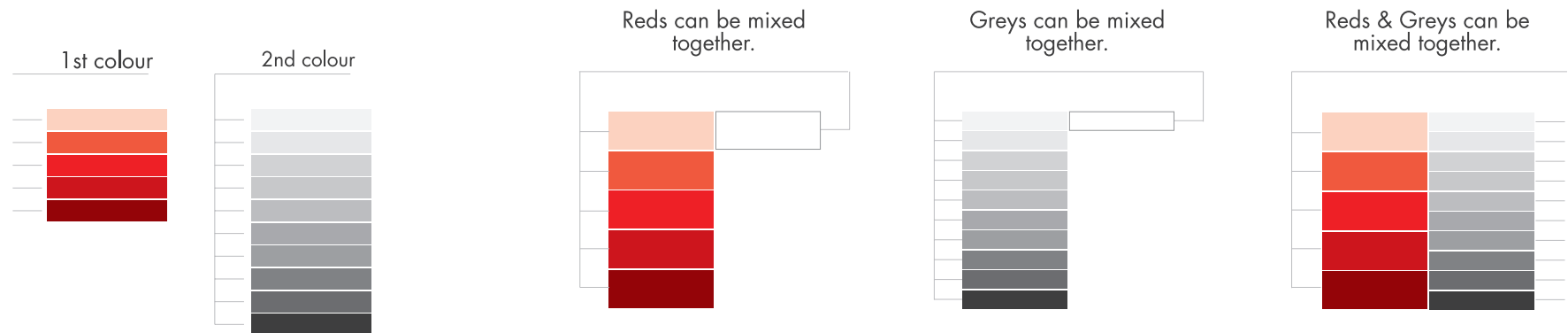

11.2 Colour rules: Illustrations

The highlights and shadows spectrum is obtained by overlaying different opacity of the highlight/shadow colour (with an interval of 40% of opacity) over the midtone colour.

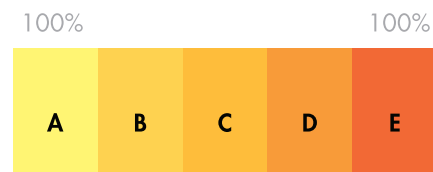

A = 100% highlight
C = 100 % midtone
E = 100% shadow

$B = C + 40\% A$
 $D = C + 40\% E$

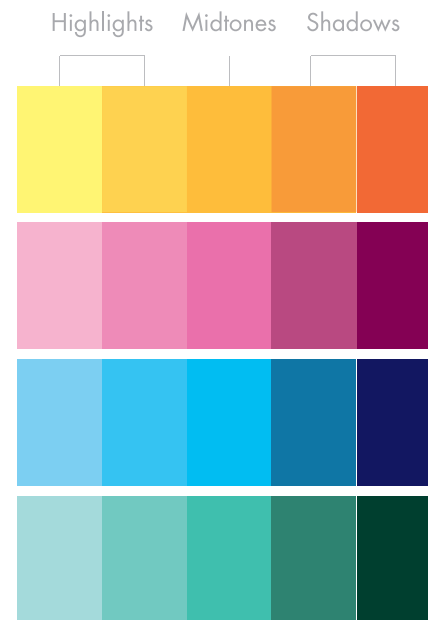
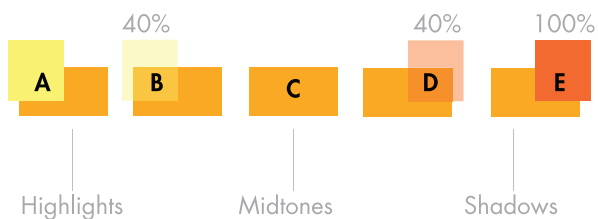

11.2 Colour rules: Illustrations- two colours combinations

The combinations below should be used when creating an illustration.

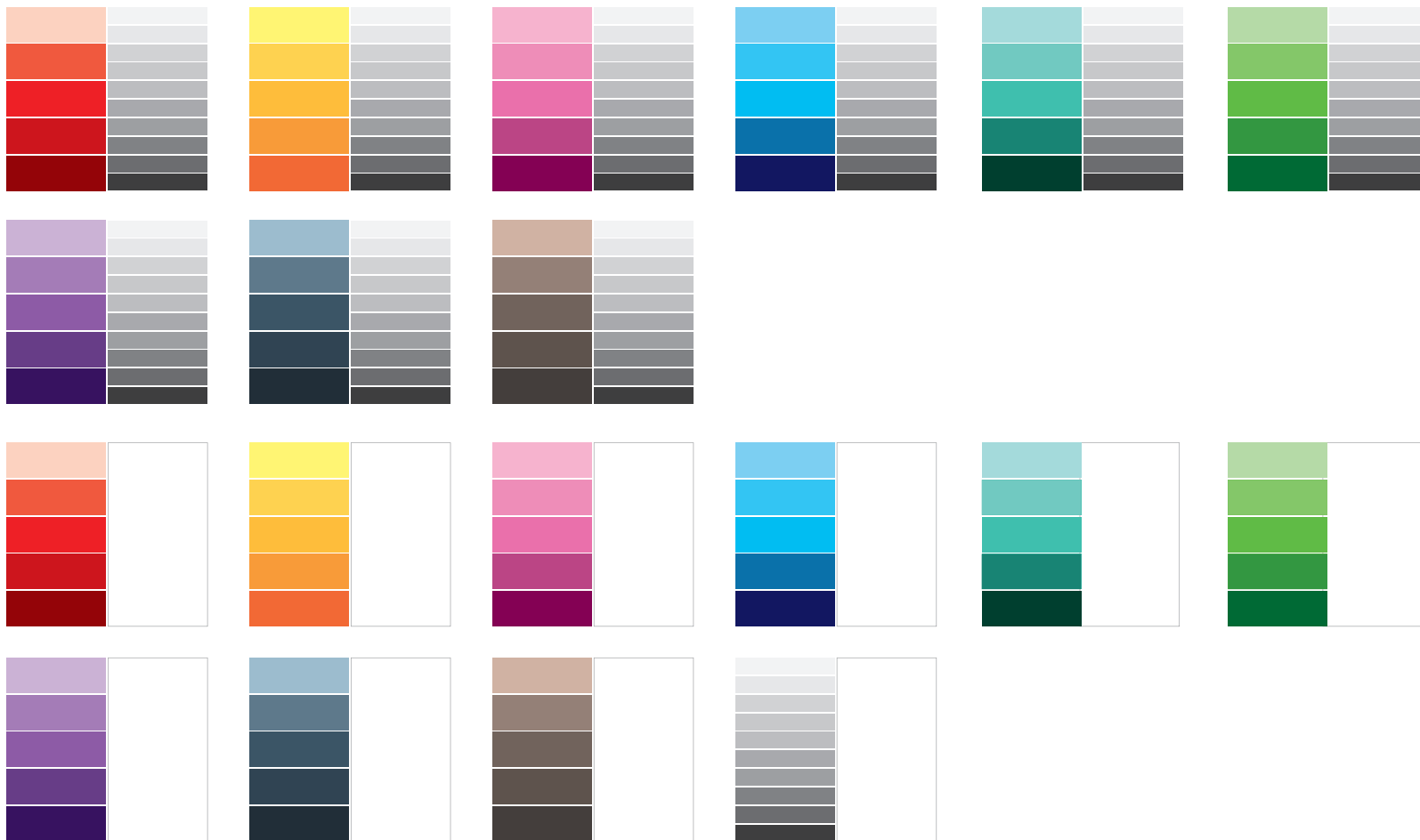

11.3 Colour codes: Primary colours

This page provides the CMYK, RGB and the HEX colour codes and values. Referring to this document will avoid to have wrong colour.



11.3 Colour codes: Secondary colours

This page provides the CMYK, RGB and the HEX colour codes and values. Referring to this document will avoid to have wrong colour.

 R255 G245 B114 C0 M20 Y68 K0 #FFF572	 R254 G189 B59 C0 M28 Y87 K0 #FEBD3B	 R242 G106 B54 C0 M73 Y87 K0 #F26A36	 R247 G179 B204 C0 M37 Y2 K0 #F7B3CC	 R232 G113 B171 C3 M70 Y0 K0 #E871AB	 R132 G0 B85 C20 M100 Y11 K41 #840055
 R125 G206 B241 C45 M1 Y0 K1 #7DCEF1	 R0 G189 B242 C75 M0 Y0 K0 #00BDF2	 R23 G27 B96 C100 M95 Y4 K42 #171B60	 R165 G219 B219 C34 M0 Y15 K0 #A5DBDB	 R71 G191 B175 C66 M0 Y39 K0 #47BFAF	 R0 G64 B47 C92 M25 Y70 K68 #00402F
 R182 G219 B166 C30 M0 Y44 K0 #B6DBA6	 R98 G107 B70 C65 M0 Y100 K0 #62BB46	 R0 G107 B53 C90 M12 Y95 K40 #006B35	 R204 G179 B215 C18 M30 Y0 K0 #CCB3D7	 R142 G51 B166 C50 M75 Y0 K0 #8E5BA6	 R56 G20 B96 C85 M100 Y0 K38 #381460
 R156 G188 B205 C31 M8 Y6 K11 #9CBCCD	 R61 G85 B103 C58 M32 Y12 K54 #3D5567	 R34 G48 B58 C75 M57 Y45 K65 #22303A	 R208 G178 B164 C5 M22 Y23 K14 #D0B2A4	 R114 G99 B93 C23 M32 Y34 K51 #72635D	 R69 G63 B61 C51 M50 Y51 K60 #453F3D

11.4 Icon backgrounds: Shape

Rounded edges will create a subtle link with the circles of Ooredoo's logo.

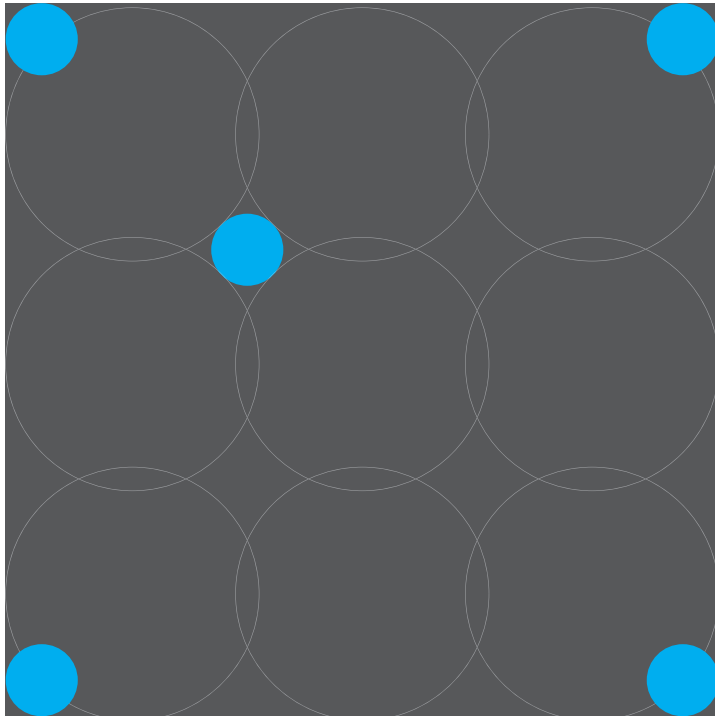

On a scale of 1/1 or on a background of 300 X 300 px, the blue circle as shown above will determine the radius of the corners of the background.



When used, An icons background always has rounded edges.

11.4 Icon backgrounds: Colours

Backgrounds for user interface & navigation icons

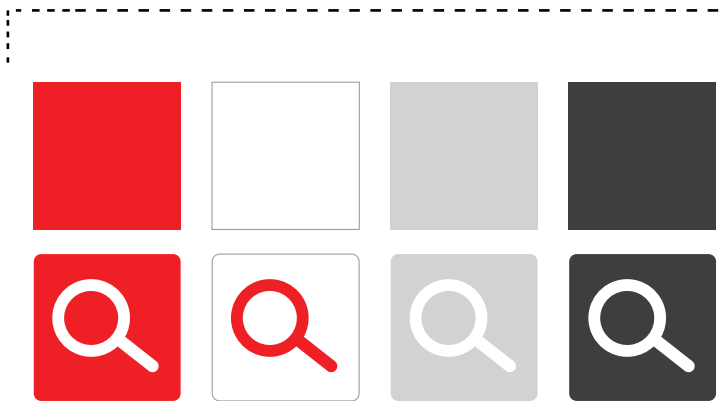

Backgrounds for Services, products & features icons

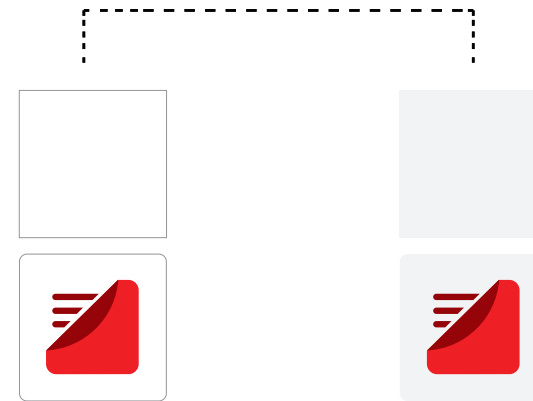

Backgrounds for user interface & navigation icons

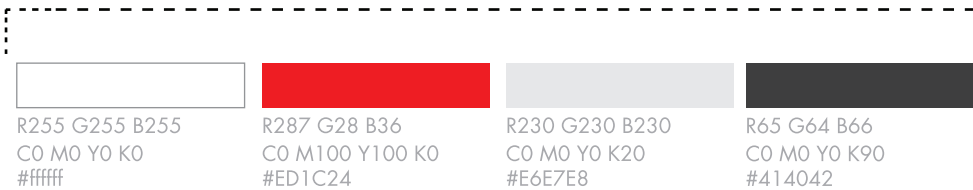

Backgrounds for Services, products & features icons

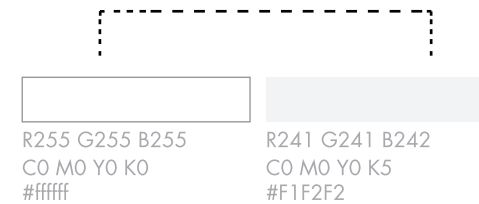

Application

- 12.1 Applying design principles : Directory icon
- 12.2 Applying design principles : Search icon
- 12.3 Applying design principles : Down arrow icon
- 12.4 Applying design principles : Forum icon
- 12.5 Applying colours: User Interface and navigation icons
- 12.6 Applying design principles : Services, products, and features icons
- 12.7 Applying colours and background: Services, products, and features icons
- 12.8 16px adjustment

The next pages will demonstrate how to apply the design principles, colours and background to Ooredoo's icon.

12.1 Applying design principles: Directory icon

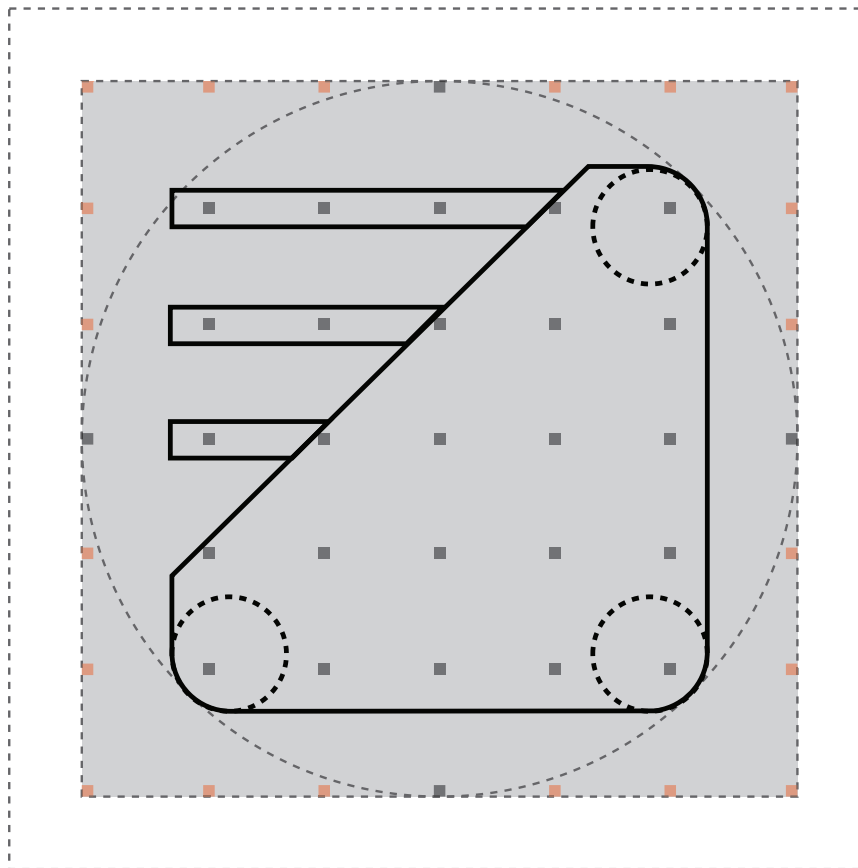

The above illustration clearly demonstrates how the icon is built up around the grid key points and how the lines intersect with the grid dots at some point but not on all the points.



First stage of the icon in black. The icon should look good both in black and in colour.

12.1 Applying design principles: Directory icon

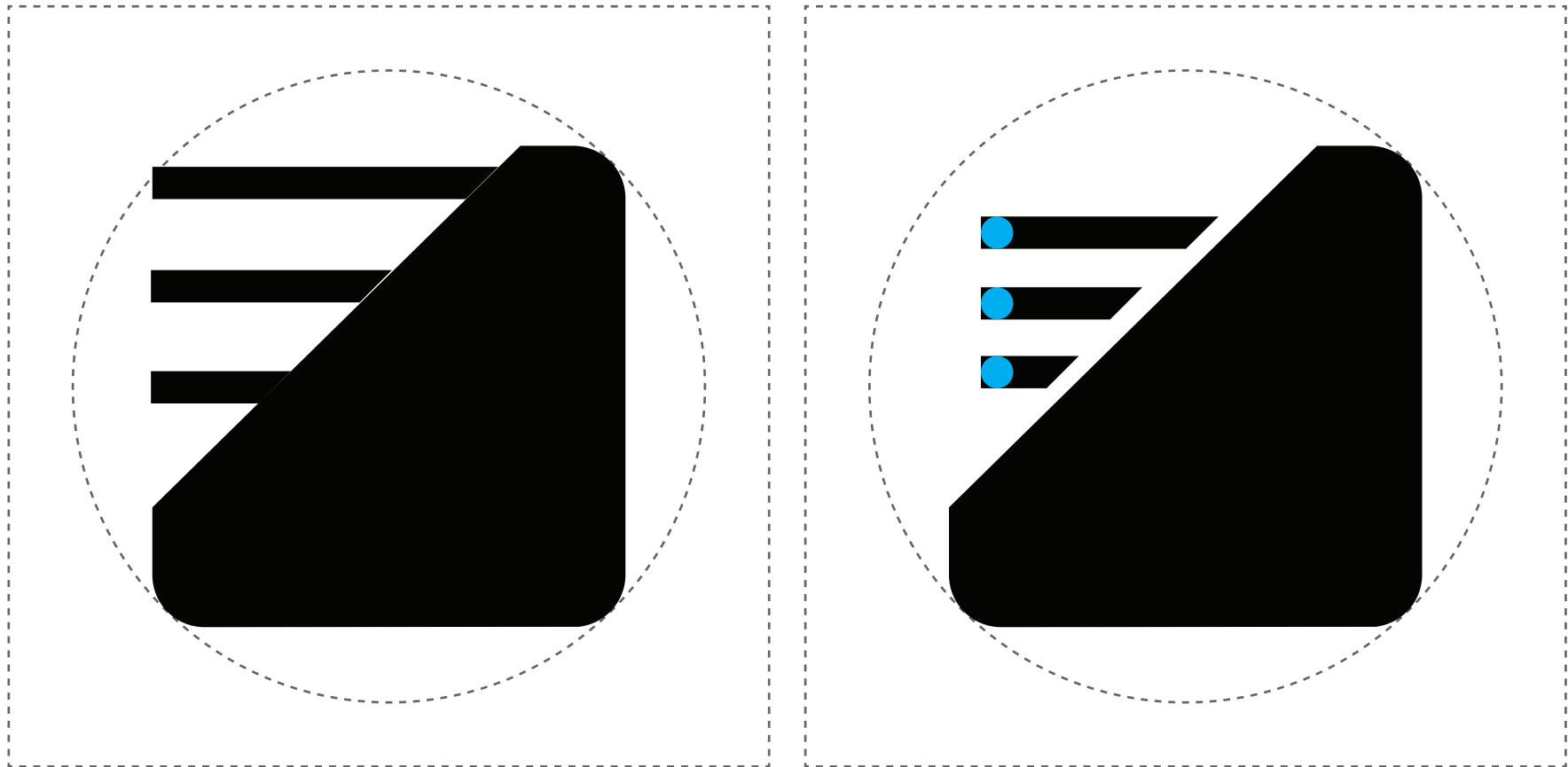

Once all the step above are completed. Some design tweaks are applied to create a balance between the negative and positive spaces of the icons.

12.1 Applying design principles: Directory icon



Final directory pages icon

12.2 Applying design principles: Search icon

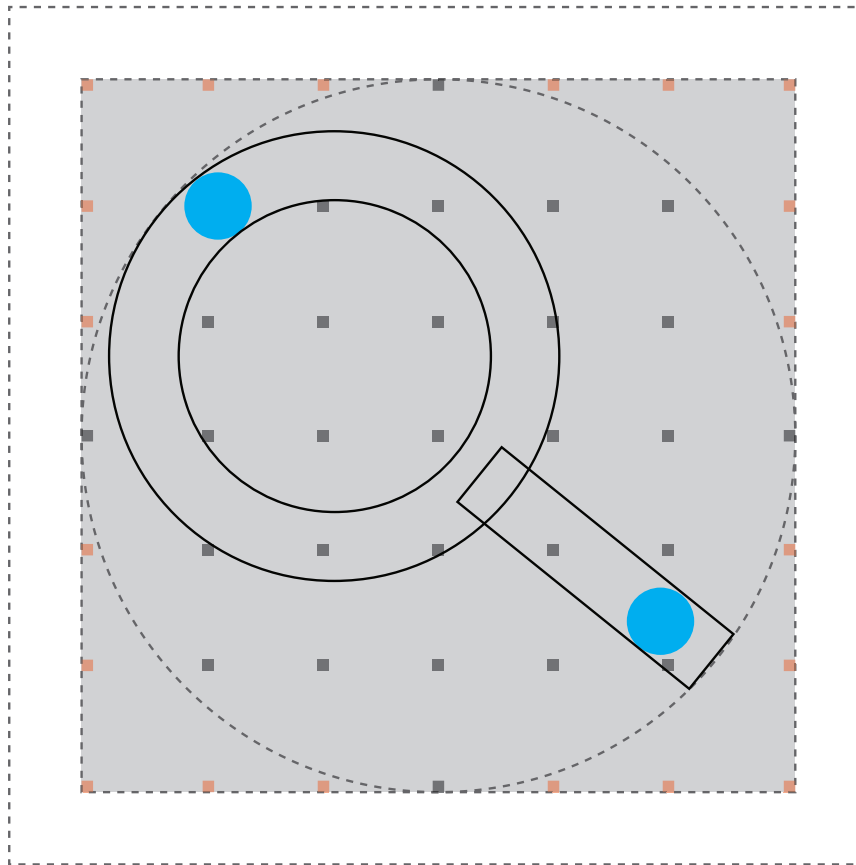

Drawing of the icon inside the grid

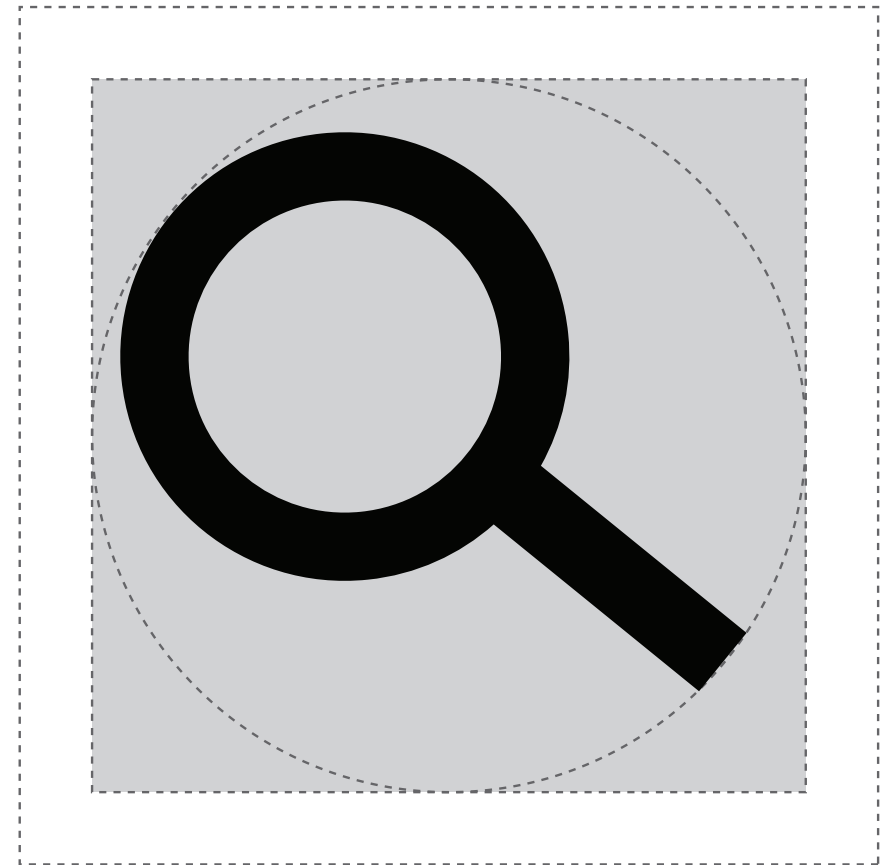

Icon in black.

12.2 Applying design principles: Search icon

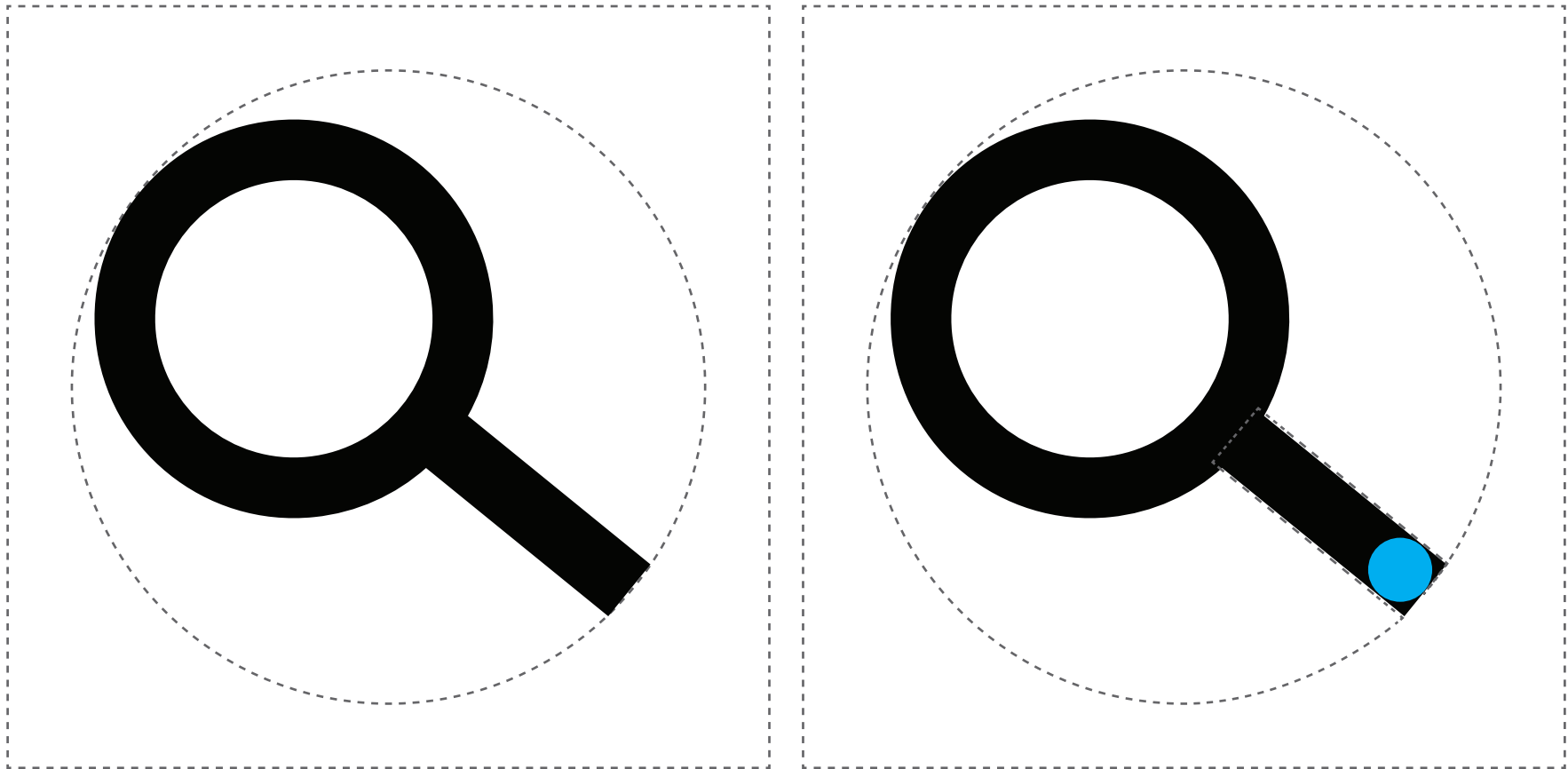

Once all the step above are completed. Some design tweaks are applied to make sure the icon is balanced. Rounded edges are checked as well

12.2 Applying design principles: Search icon

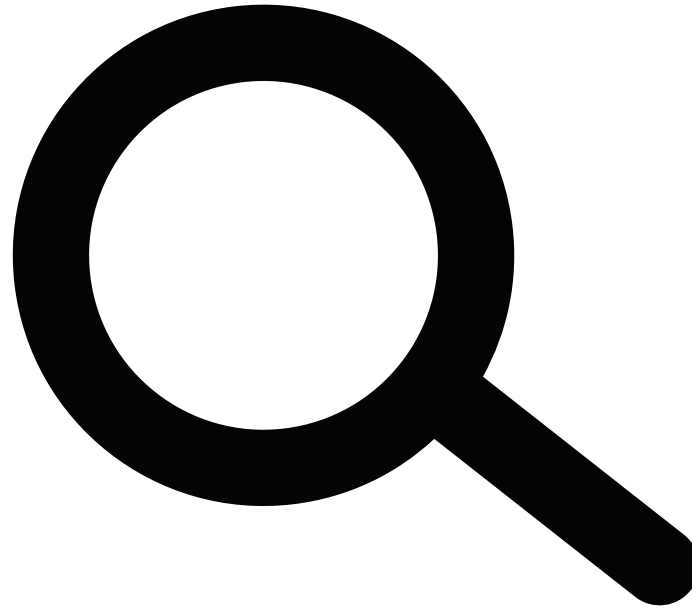

Final search icon

12.3 Applying design principles: Down arrow icon

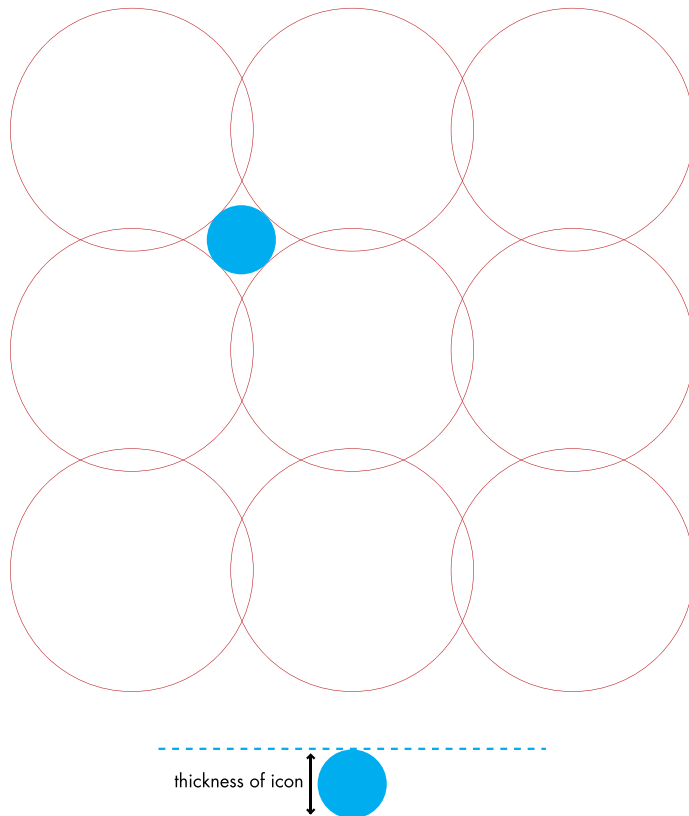

Above image demonstrates how the blue circle determines the thickness of the icon. Also it will determine the radius of the rounded edges. (next slide)

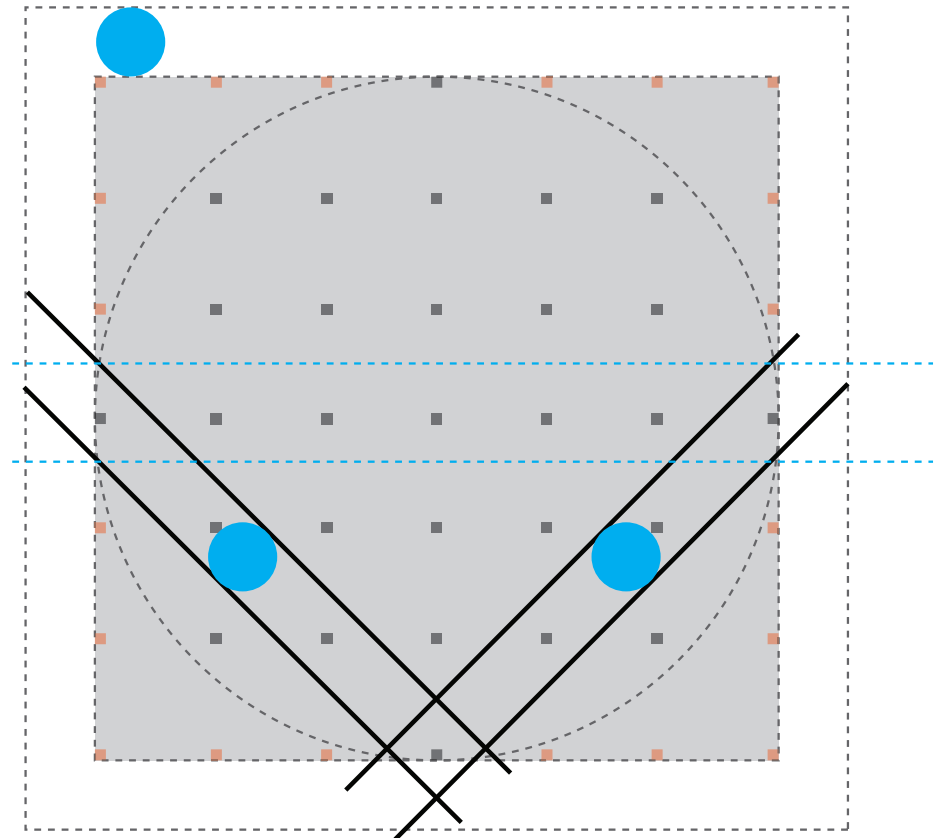

Drawing of the icon inside the grid.

12.3 Applying design principles: Down arrow icon

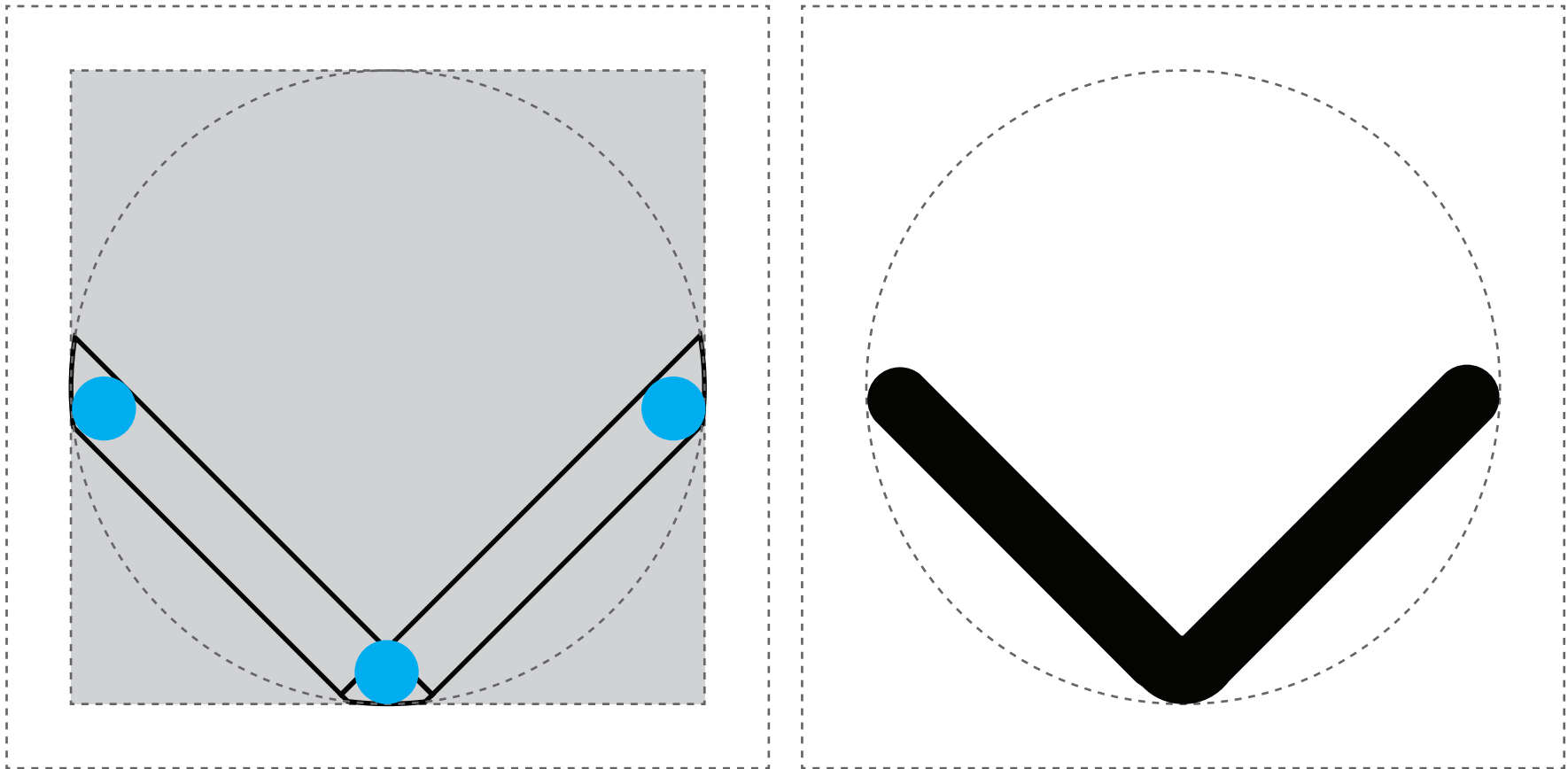

Design tweaks are applied to make the icon look nicer.

12.3 Applying design principles: Down arrow icon

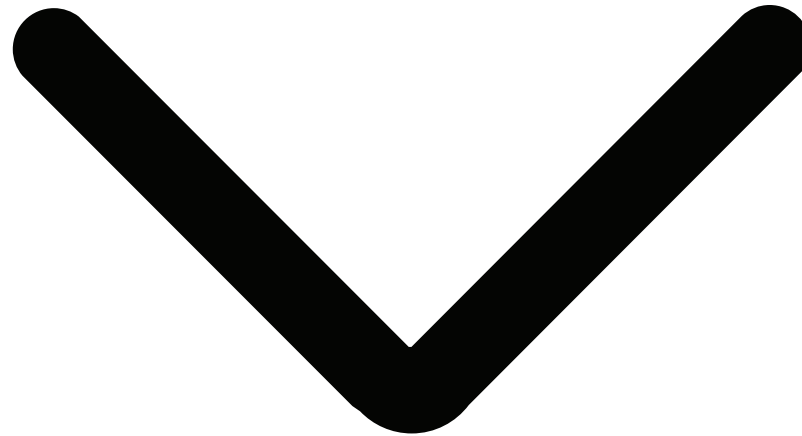

Final down arrow icon

12.4 Applying design principles: Forum icon

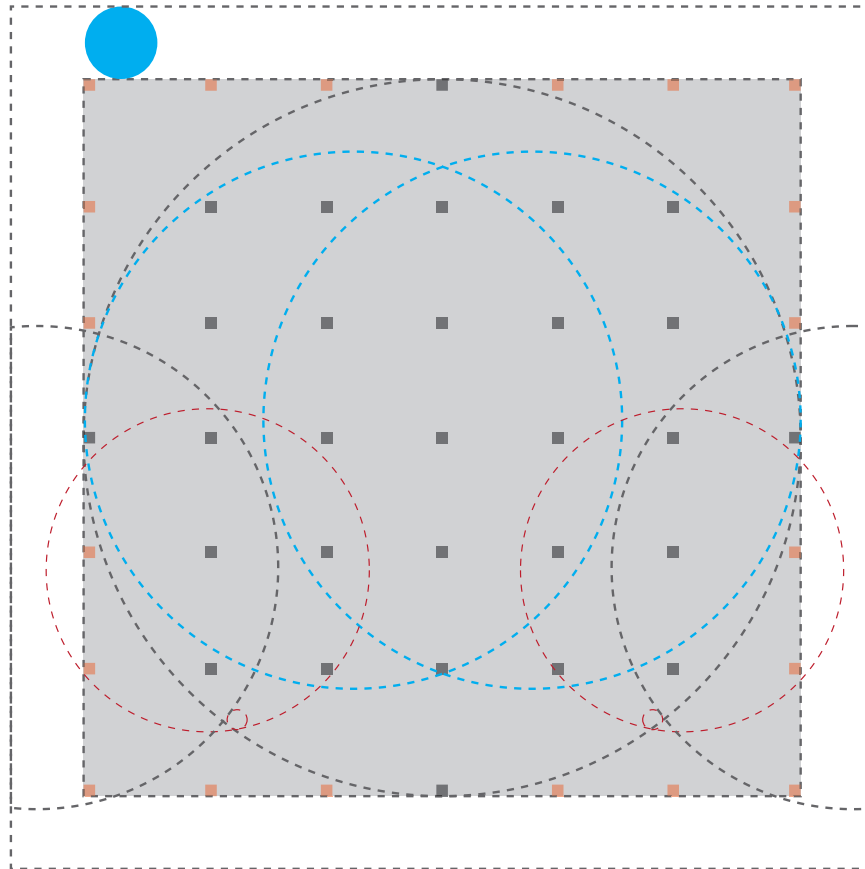

Drawing of the icon based on circles and geometrical shapes.

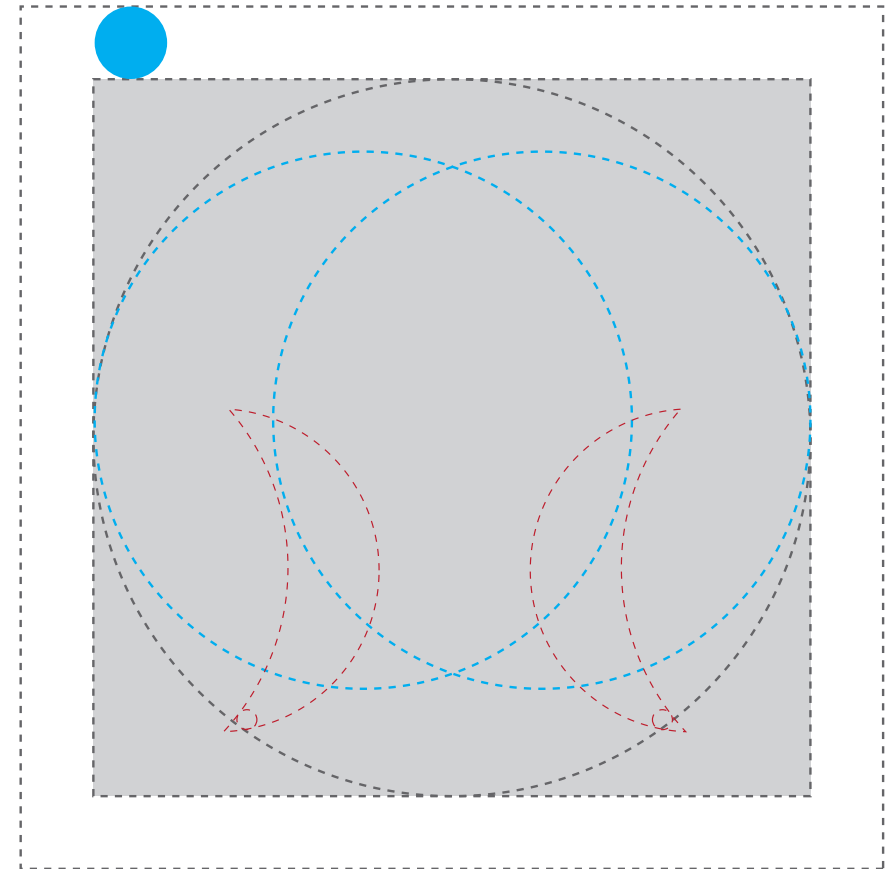

Unnecessary parts are eliminated step by step.

12.4 Applying design principles: Forum icon

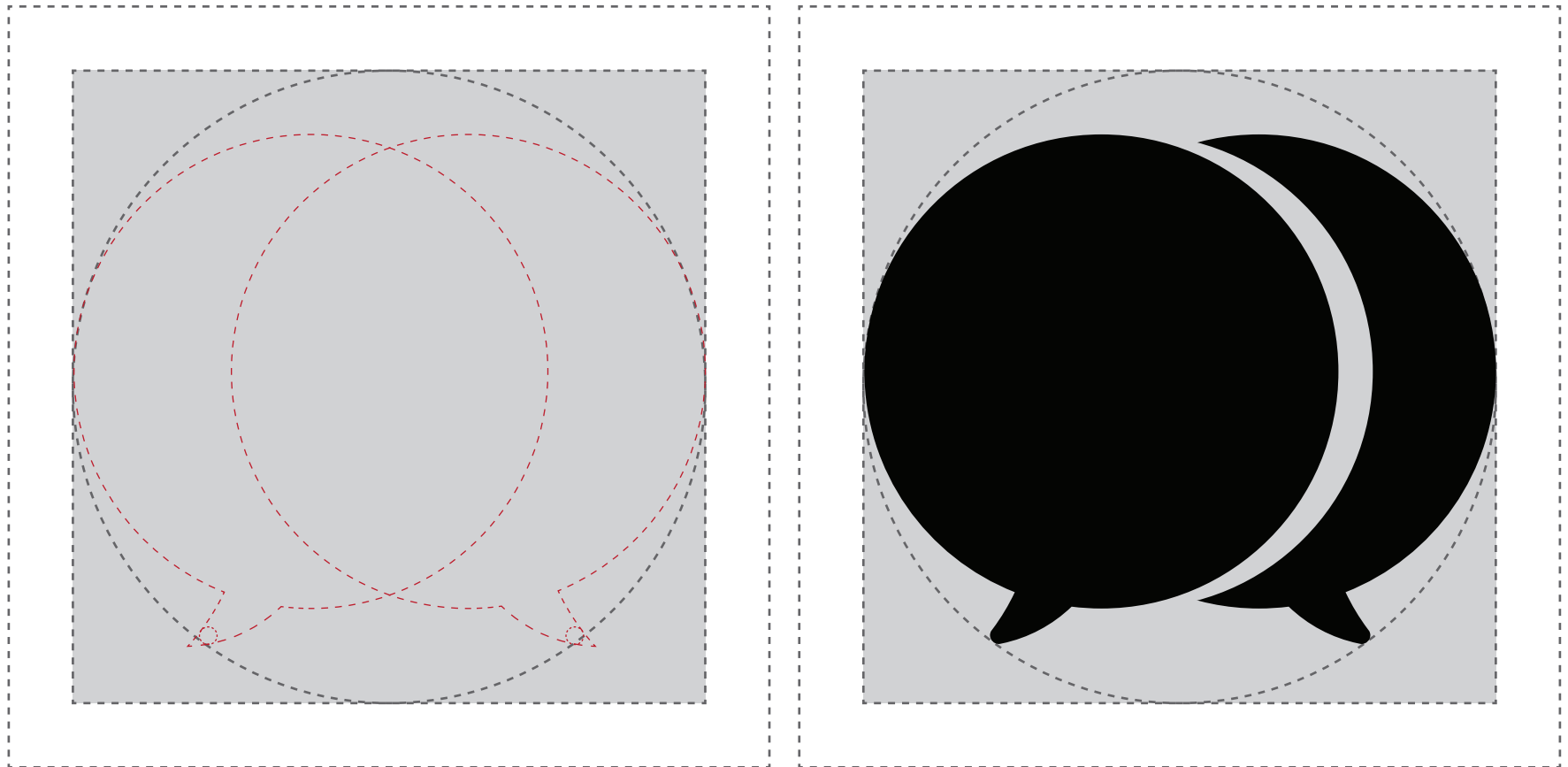

Icon in black. Rounded edges and design tweaks are applied.

12.4 Applying design principles: Forum icon

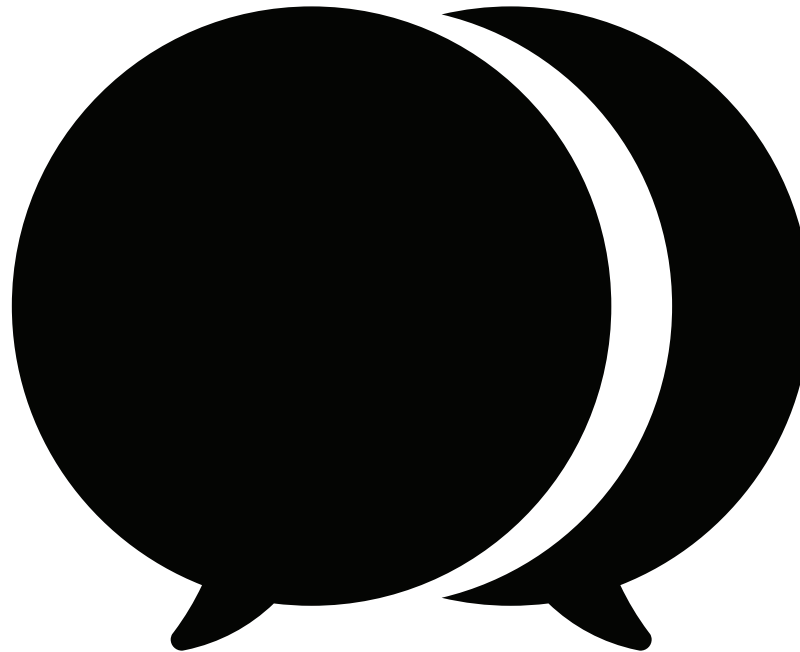

Final forum icon

12.5 Applying colours: User interface and navigation icons

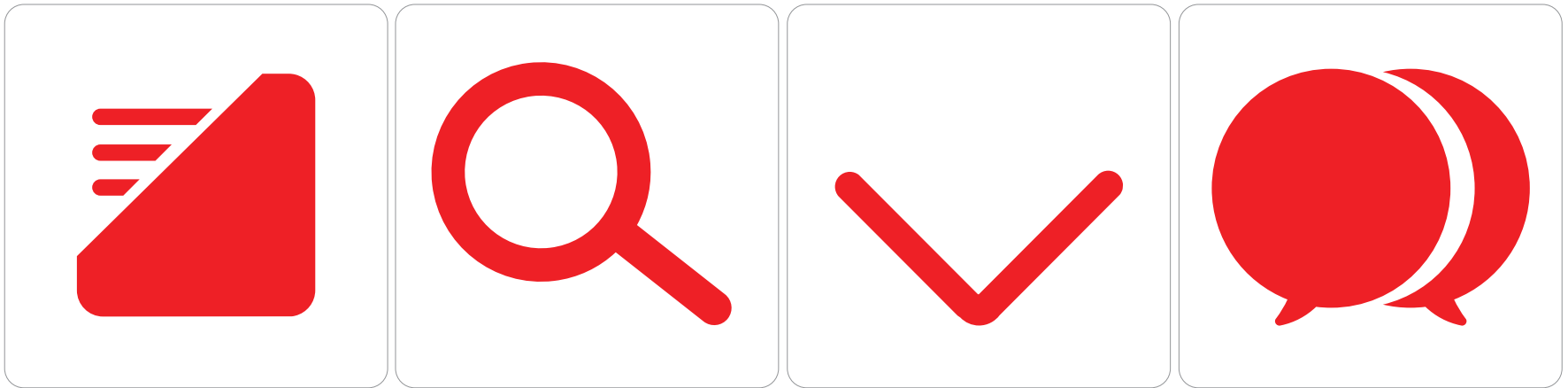







Directory

Search

Arrow down

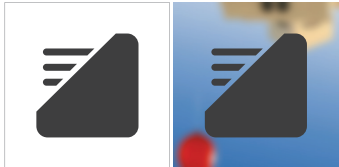
Forum

12.5 Applying backgrounds: User interface and navigation icons/Direc-

Icon colour	Rule of use	Application
	<p>The red icon (#ED1C24) can only be used on</p> <ul style="list-style-type: none"> • White background 	
	<p>The dark grey icon(#414042) can only be used on</p> <ul style="list-style-type: none"> • White background • Bright image background to create contrast 	
	<p>The light grey icon (#E6E7E8) can only be used on</p> <ul style="list-style-type: none"> • White background • Dark grey background (#414042) • Dark image background to create contrast 	
	<p>The white icon (#E6E7E8) can only be used on</p> <ul style="list-style-type: none"> • Red background (#ED1C24) • Light grey background (#E6E7E8) • Dark grey background (#414042) • Dark image background to create contrast 	

12.6 Applying design principles: Services, products, and features icons

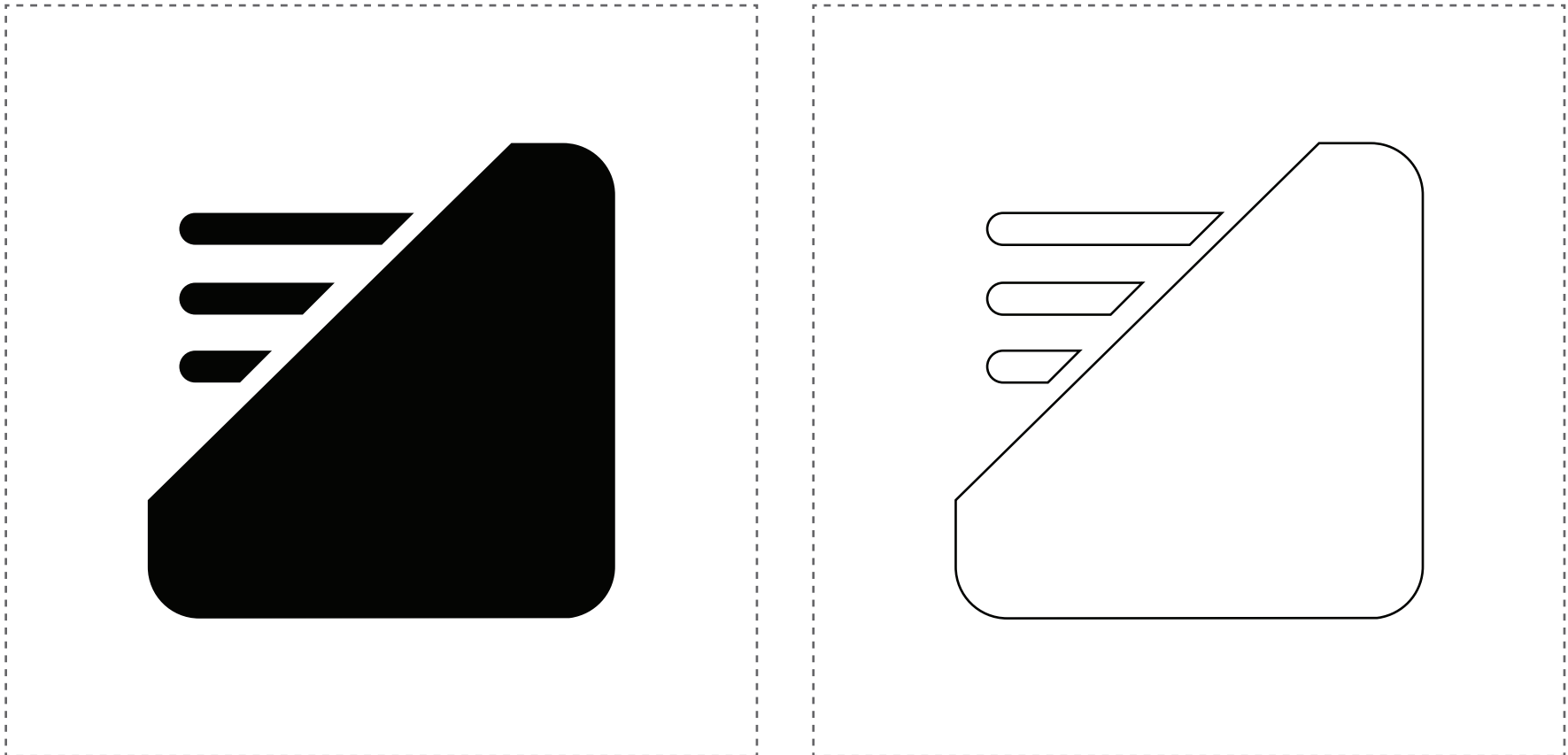

This is the Directory icon designed above in the document. The next steps will demonstrate how to add depth and make it an Ooredoo service or feature icon.

12.6 Applying design principles: Services, products, and features icons

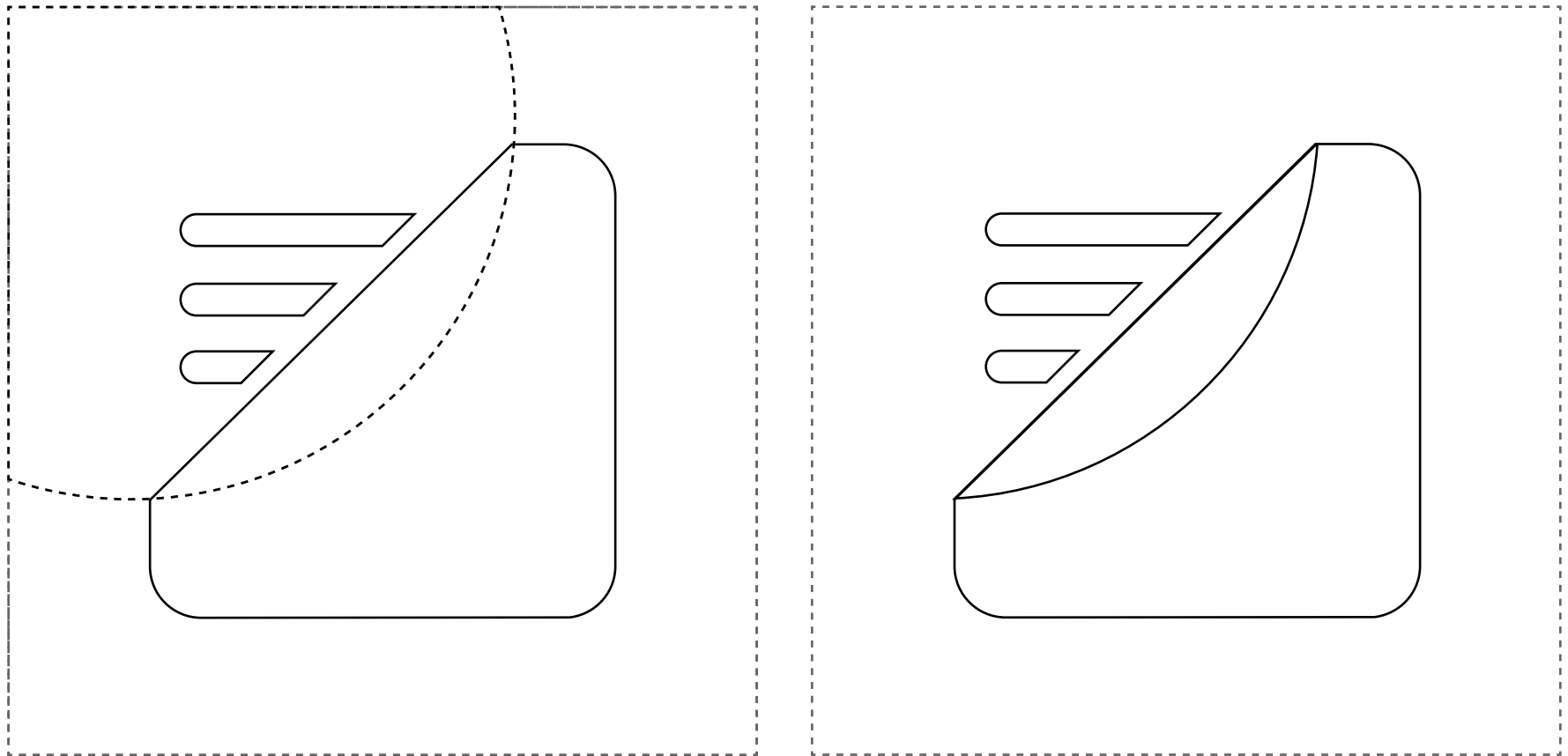

Adding more depth and detail to the illustration. In this case a “folding” effect will be created using circles and geometrical shapes. By using circles the connection with the Ooredoo logo circles will be kept.

12.7 Applying colours and background: Services, products, and features icons



Icon is resized to 300 X 300px
Icon using two shades of red from the primary colour combinations rule.



Background corners are rounded.
Final look of the icon.

12.7 Applying colours and background: Services, products, and features icons

Please note that these examples are only for the purpose of this exercise. They demonstrate the 2 colour combination rule and how it could be applied. The example is only to demonstrate the diversity that the different services, products and features icons can have by changing with the two primary colours of Ooredoo. In no case will one service or product have two different ways of displaying.



Using red on a grey background



Using grey on a grey background

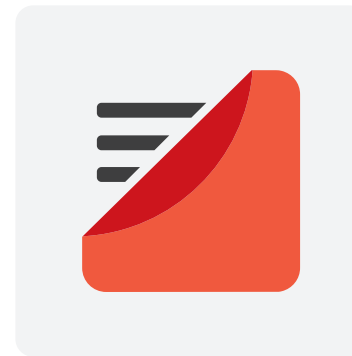

Using red and grey on a grey background

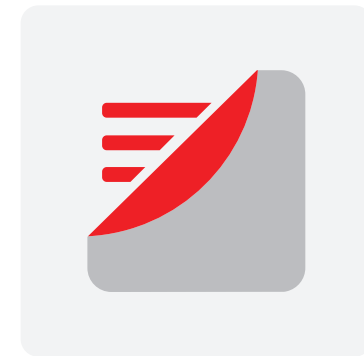

Using red and grey on a grey background



Using grey on a white background



Using red and grey on a white background



Using red on a white background



Using red and grey on a white background

12.7 Applying colours and background: Services, products, and features icons

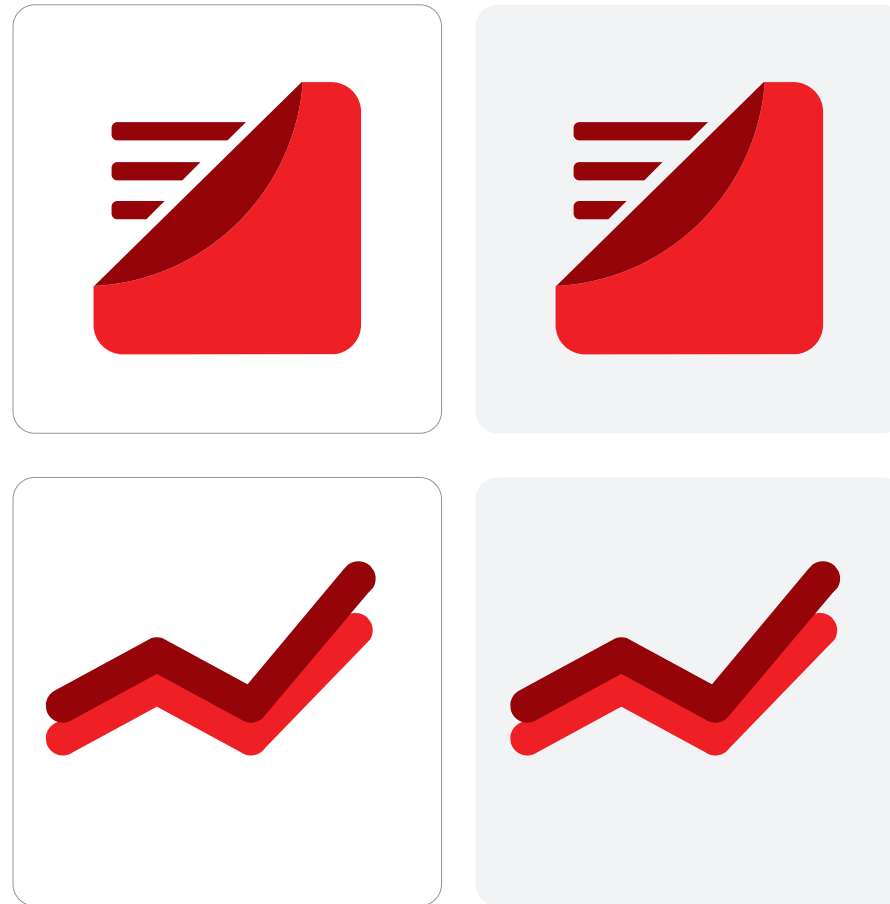

12.8 16px adjustment



At 16px, negative and positive space change. Some design fixes will need to apply in some scenarios.



Call to action - CTA

- 13.1 Clear space
- 13.2 Minimum width and height
- 13.3 Colour principles
- 13.4 Font (family, colour, size)
- 13.5 Behaviour states (over and click)
- 13.6 Application

To keep a consistency throughout Ooredoo's market websites, consistency in call to actions is required. How a call to action is displayed, what colour does it use, what font does it have, what is its minimum size, its behaviour state, all these questions need to be answered when designing a button.

13.1 CTA clear space: Only text CTA

Clear space is the minimum “breathing room” maintained around the text of the CTA. It is kept free of graphics, text and other marks.

- The minimum horizontal clear space around the text of a CTA is equal to $1/3X$.
- The maximum horizontal clear space around the text of a CTA is equal to $1/2X$.
- The vertical clear space around the text of a CTA is invariable and is always equal to $1/3X$.
- The height of the small cap of the font is equal to $1/3$ of the total height of the CTA.
- Ooredoo’s CTA have always rounded edges.

Minimum clear space figure

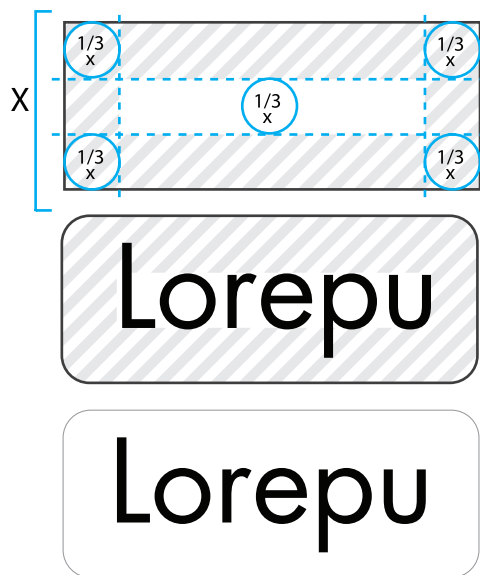

Maximum clear space figure

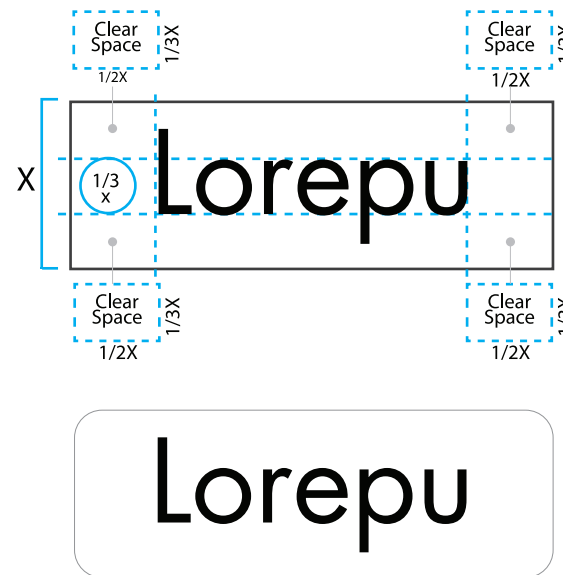

13.1 CTA clear space: Only text CTA

Clear space is the minimum “breathing room” maintained around the icon in the CTA. It is kept free of graphics, text and other marks.

- The maximum horizontal clear space around the text of a CTA is equal to $1/10X$.
- The minimum horizontal clear space around the text of a CTA is equal to $1/10X$.
- The vertical clear space around the text of a CTA is invariable and is always equal to $1/10X$.
- Ooredoo’s CTA are have always rounded edges.

Minimum clear space figure

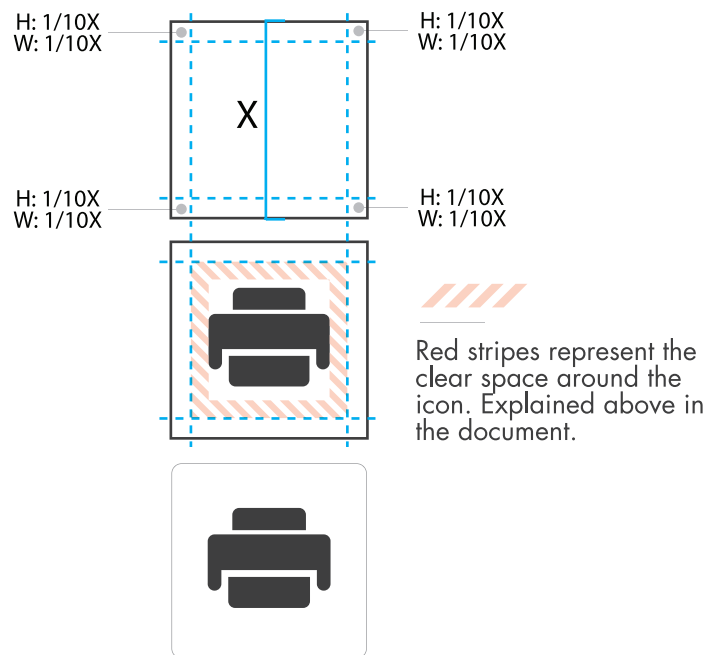

Maximum clear space figure

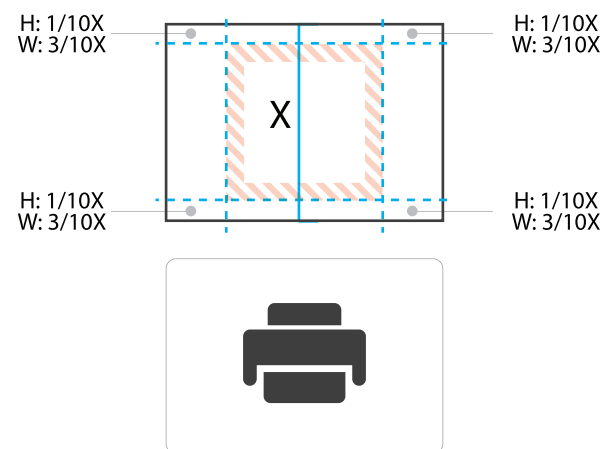

13.1 CTA clear space: Text + Icons CTA

Clear space is the minimum “breathing room” maintained around the text and Icon CTA. It is kept free of graphics, text and other marks.

- The horizontal and vertical breathing space in a “Text + Icon CTA” is invariable.
- The height of the small cap of font is equal to $1/3$ of the total height of the CTA.
- The vertical clear space around the text and icon of a CTA is invariable and is always equal to $1/3X$.
- The horizontal clear space around the icon is $1/3X$.
- The horizontal clear space around the text is $1/3X$.
- Ooredoo’s CTAs have always rounded edges.

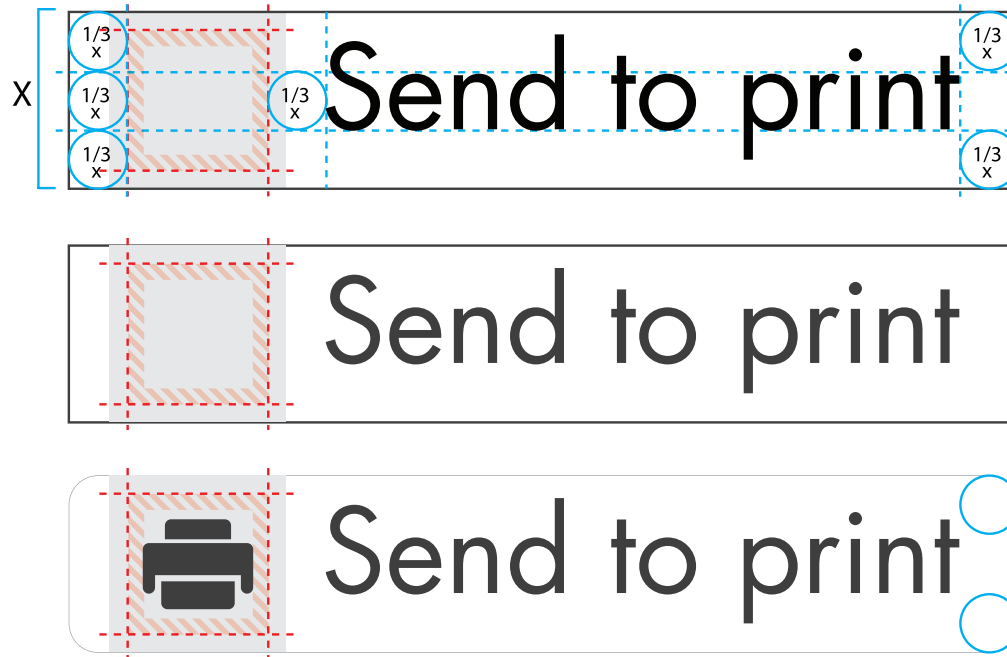

13.2 CTA minimum width and height

Respecting the rules of minimum width and height will allow for a consistency regarding the display of CTA on Ooredoo's market websites.

There are 3 different CTA buttons.

- CTA with only text.
- CTA with only icon.
- CTA with text and icon.

A rounded rectangular button with a thin black border containing the text "Lorem Ipsum".

Lorem Ipsum

CTA is only TEXT

Minimum Height is 33 px.
After that the font is not readable anymore



CTA is only ICON

Minimum height and width
is 20 px.

A rounded rectangular button with a thin black border containing a printer icon followed by the text "Lorem Ipsum".

 Lorem Ipsum

CTA is only TEXT & ICON

Minimum Height is 33 px.
After that the font is not readable anymore

CTA colour principles

Call to actions for user interface and navigation icons follow the same principles of Icons background explained earlier in the document. However depending on the importance of a call to action the designer can choose to use a strong colour like red or dark grey.

Remember

- CTA colour backgrounds follow the same principles of icons colours background.
- CTA have a 1px stroke.
- The colour of the stroke is one tone darker than the colour of the background.

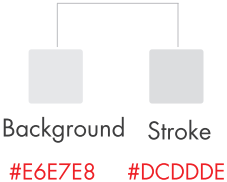
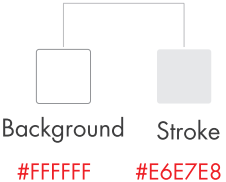
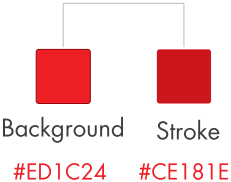

CTA is only TEXT



CTA is only ICON



CTA is only TEXT & ICON

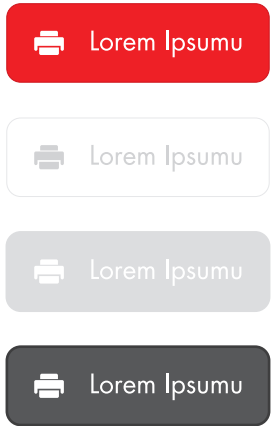

13.4 CTA font

When thinking font for CTA, small scale display should be taken into consideration. For better display reasons FUTURA BOOK is the font used for CTAs.

Remember

- The font colour act the same way as the icons colours.
- The font size will depend on the CTA size. Keeping in mind the breathing space.

Brief comparaisn between the two Ooredoo's main fonts:



FUTURA BOOK

Send to print

Send to print

Send to print _____ *At 10 point the font is still readable*



OOREDOO- BETA 5 REGULAR

Send to print

Send to print

Send to print _____ *At 10 point the font is not clear anymore as the space between letter was not conceived for a digital format*

CTA and Icons: Behaviour states- Over and click

Below are the figures showing how on over and click state the CTAs and buttons behave.

Background Colour

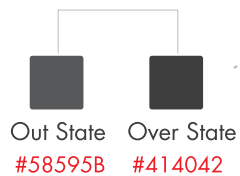
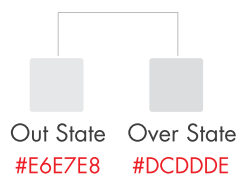
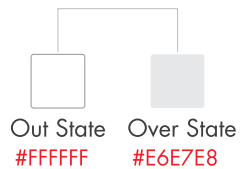
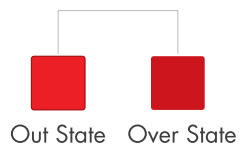

Stroke Colour

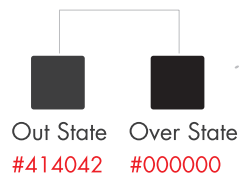
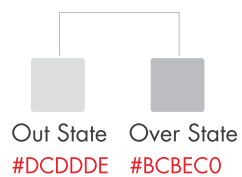
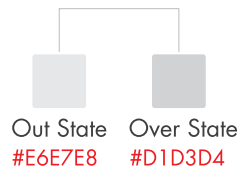
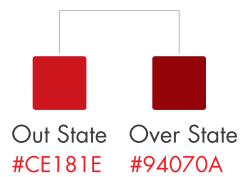



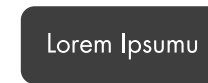
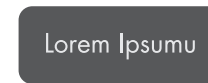
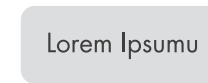
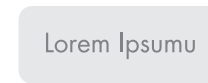
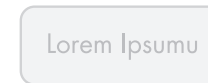
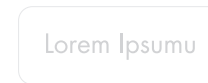
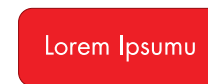
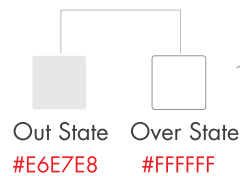
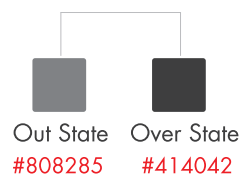
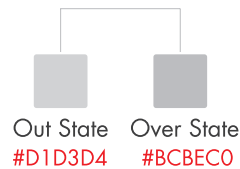
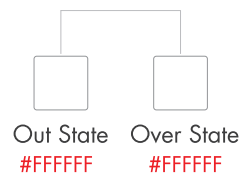

















Text Colour



Application

It is by having the right balance between these three ways of displaying a CTA on an online page that we achieve best user experiences and design interfaces.

CTA Icon+ Text	Only Version				
CTA Icon Only	Condensend version				
	Extended version				
CTA Text Only	Condensend version				
	Extended version				

Iconography library

14.1 Listing nomenclature

14.2 Asset listing

In the light of keeping a record of all the Ooredoo's iconography created throughout the markets, a simple nomenclature system and checklist sheet apply.

14.1 Listing nomenclature

In order to easily surf, search and classify ooredoo iconography we suggest a simple nomenclature rule.





























UIN = User interface and navigation icon
 PSF = Service, product, and application icon
 ILL = Feature and illustration icons











































Name	Category	Code
Print	User interface and navigation	OO_UIN_000
Sign Up	User interface and navigation	OO_UIN_001
eshop	Service, Products and application	OO_PSF_000
4G	Service, Products and application	OO_PSF_001
Illustration 1	Illustration	OO_ILL_000

14.2 Asset listing

































Below are icons to be used across all Ooredoo digital platforms.

 OO_UI_001	 OO_UI_011	 OO_UI_021	 OO_UI_031
 OO_UI_002	 OO_UI_012	 OO_UI_022	 OO_UI_032
 OO_UI_003	 OO_UI_013	 OO_UI_023	 OO_UI_033
 OO_UI_004	 OO_UI_014	 OO_UI_024	 OO_UI_034
 OO_UI_005	 OO_UI_015	 OO_UI_025	 OO_UI_035
 OO_UI_006	 OO_UI_016	 OO_UI_026	 OO_UI_036
 OO_UI_007	 OO_UI_017	 OO_UI_027	 OO_UI_037
 OO_UI_008	 OO_UI_018	 OO_UI_028	 OO_UI_038
 OO_UI_009	 OO_UI_019	 OO_UI_029	 OO_UI_039
 OO_UI_010	 OO_UI_020	 OO_UI_030	 OO_UI_040





















14.2 Asset listing

 OO_UI_041	 OO_UI_051	 OO_UI_061	 OO_UI_071
 OO_UI_042	 OO_UI_052	 OO_UI_062	 OO_UI_072
 OO_UI_043	 OO_UI_053	 OO_UI_063	 OO_UI_073
 OO_UI_044	 OO_UI_054	 OO_UI_064	 OO_UI_074
 OO_UI_045	 OO_UI_055	 OO_UI_065	 OO_UI_075
 OO_UI_046	 OO_UI_056	 OO_UI_066	 OO_UI_076
 OO_UI_047	 OO_UI_057	 OO_UI_067	 OO_UI_077
 OO_UI_048	 OO_UI_058	 OO_UI_068	 OO_UI_078
 OO_UI_049	 OO_UI_059	 OO_UI_069	 OO_UI_079
 OO_UI_050	 OO_UI_060	 OO_UI_070	 OO_UI_080

14.2 Asset listing

 OO_UI_081	 OO_UI_091	 OO_UI_101	 OO_UI_111
 OO_UI_082	 OO_UI_092	 OO_UI_102	 OO_UI_112
 OO_UI_083	 OO_UI_093	 OO_UI_103	FR OO_UI_113
 OO_UI_084	 OO_UI_094	 OO_UI_104	KU OO_UI_114
 OO_UI_085	 OO_UI_095	 OO_UI_105	EN OO_UI_115
 OO_UI_086	 OO_UI_096	 OO_UI_106	AR OO_UI_116
 OO_UI_087	 OO_UI_097	 OO_UI_107	f OO_UI_117
 OO_UI_088	 OO_UI_098	 OO_UI_108	g+ OO_UI_118
 OO_UI_089	 OO_UI_099	 OO_UI_109	in OO_UI_119
 OO_UI_090	 OO_UI_100	 OO_UI_110	 OO_UI_120

14.2 Asset listing

 OO_UI_121	 OO_UI_131	 OO_UI_141
 OO_UI_122	 OO_UI_132	
 OO_UI_123	 OO_UI_133	
 OO_UI_124	 OO_UI_134	
 OO_UI_125	 OO_UI_135	
 OO_UI_126	 OO_UI_136	
 OO_UI_127	 OO_UI_137	
 OO_UI_128	 OO_UI_138	
 OO_UI_129	 OO_UI_139	
 OO_UI_130	 OO_UI_140	

14.3 Conclusion

In a nutshell, what makes Ooredoo iconography unique to the brand.

- It is built inside a circle.
- It uses Ooredoo primary colours.
- It uses rounded edges giving a more friendly look and feel.
- It uses skeumorphic flat design and follows the latest trends.
- It is built using geometrical shapes.
- It is cool like the brand.

Social media

Social media creative guidelines

- 15.1 Social media icons
- 15.2 Facebook
- 15.3 Twitter
- 15.4 Youtube
- 15.5 Pinterest
- 15.6 Instagram
- 15.7 Google +
- 15.8 LinkedIn
- 15.9 Tumblr

15.1 Social media icons

Beautiful, dynamic, compelling and minimalistic icons are part of **Ooredoo** user experience online as they play an important role in communicating with the users.



Facebook



Google +



Linked In



Twitter



Instagram

Examples on how to use the social media icon



Social media icon in white. The background using the respective color of the social media channel.



Social media icon in white

15.2 Facebook: General design guide

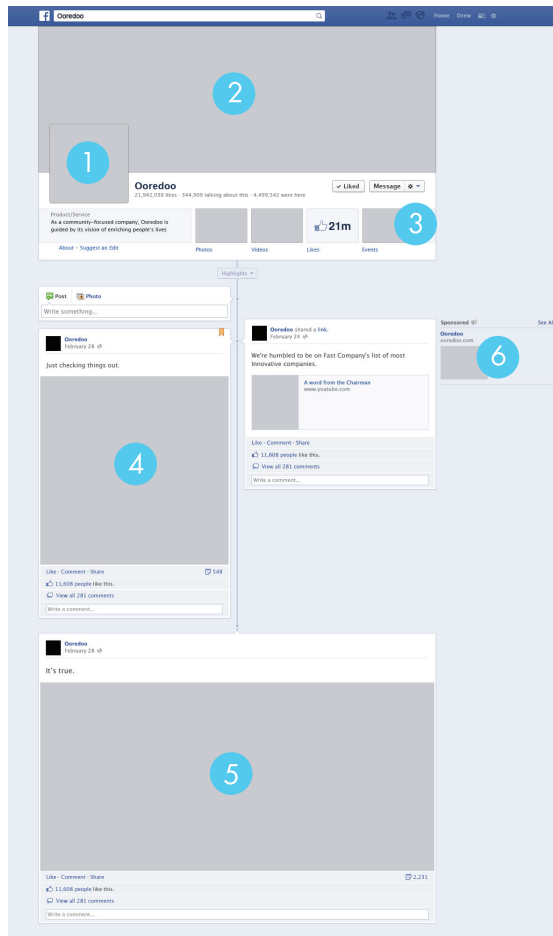

- 1 **Profile picture**
Dimension: 180 x 180 pixels
File format: JPG and PNG
Recommended file size: 100 kilobytes
- 2 **Cover image**
Dimension: 851 x 315 pixels
File format: JPG and PNG
Recommended file size: 100 kilobytes
- 3 **Tab image**
Dimension: 111 x 74 pixels
File format: JPG and PNG
Recommended file size: 100 kilobytes
- 4 **Regular post image**
Dimension: 403 x 403 pixels
File format: JPG and PNG
Recommended file size: 100 kilobytes
- 5 **Highlighted post image**
Dimension: 843 x 403 pixels
File format: JPG and PNG
Recommended file size: 200 kilobytes
- 6 **Ads**
Dimension: 100 x 72 pixels
File format: JPG and PNG
Max file size: 5 megabytes

Profile picture

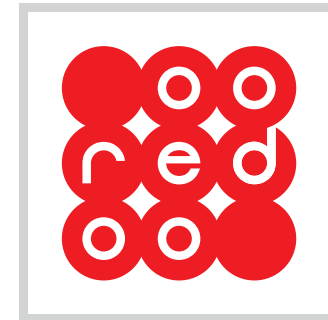

Use the red stacked logo of Ooredoo as a profile picture at all times. Add a 20 pixel white space between the logo and the edge.



Tips on image size optimisation

Always "Save As" for web and devices. Do not forget to tick the "Convert to sRGB" box. The JPG image format is a lossy format, meaning you sacrifice picture quality to save file size. PNG files will be slightly larger, but will keep your details in-tact; which is very important if you will be using small text in your background.

For more information visit:

<https://www.facebook.com/help/>

15.2 Facebook: General design guide



- 7** Event image
Dimension: 851 x 315 pixels
File format: JPG and PNG
Recommended file size: 100 kilobytes

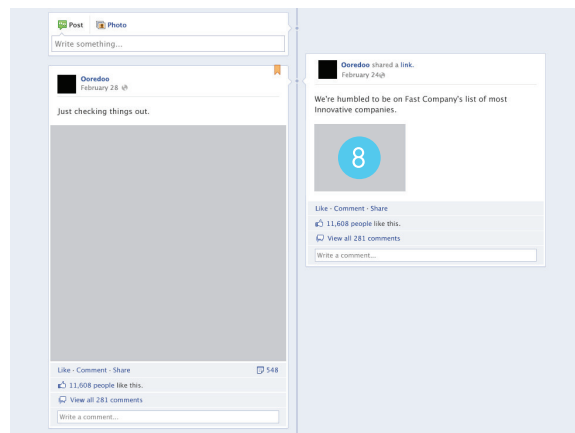

- 8** Link preview
Dimension: 114 x 155 pixels
File format: JPG and PNG
Recommended file size: TC

Profile picture

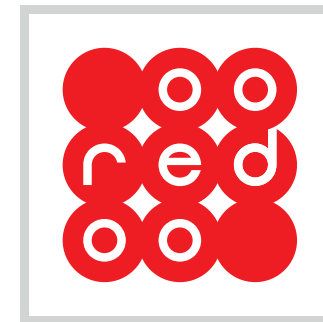

Use the red stacked logo of Ooredoo as a profile picture at all times. Add a 20 pixel white space between the logo and the edge.



Tips on image size optimisation

Always “Save As” for web and devices. Do not forget to tick the “Convert to sRGB” box. The JPG image format is a lossy format, meaning you sacrifice picture quality to save file size. PNG files will be slightly larger, but will keep your details in-tact; which is very important if you will be using small text in your background.

For more information visit:

<https://www.facebook.com/help/>

15.2 Facebook: Content look and feel - Consumer oriented

The look and feel for consumer oriented content should be fun, active, uplifting and stand out. We can show this by choosing an optimistic visual with an energetic composition, good lighting and by keeping 1 key message (please refer to the photography guidelines in the Ooredoo brand book). Below are examples that you can refer to.

Cover image - Consumer



Tab image - Consumer



Post image - Consumer



Ads - Consumer



15.2 Facebook: Content look and feel - Consumer oriented

The look and feel for business oriented content should be energetic, positive, uplifting and stand out. We can show this by choosing an optimistic visual with good composition and lighting. Avoid using boring images (please refer to the photography guidelines in the Ooredoo brand book). Keep in mind that the models should be in business attire. Below are examples that you can refer to.

Cover image - Business



Tab image - Business



Post image - Business



Ads - Business



15.2 Facebook: Content look and feel - Consumer oriented



The look and feel of the Facebook page.

- **Cover Image example**

Showcasing a branded Ooredoo Facebook cover image using the circle grid, eye catching visual, and inverted diamond grid.



Note:

The rounded corners were based on the diameter of the Ooredoo circles on the profile picture.

- **Tab examples**

Showcasing branded Ooredoo Facebook tab, using the circle grid or the inverted diamond grid, the Ooredoo colours, Ooredoo font and the brand iconography.

15.2 Facebook: Content look and feel - Consumer oriented



The look and feel of the Facebook page.

- Regular post example

Showcasing a branded Ooredoo Facebook post using the circle grid, eye catching visual, inverted diamond grid and the horizontal Ooredoo logo.



Note:

Ads and sponsored stories in News Feed may not include images comprised of more than 20% text.

15.2 Facebook: Content look and feel - Consumer oriented

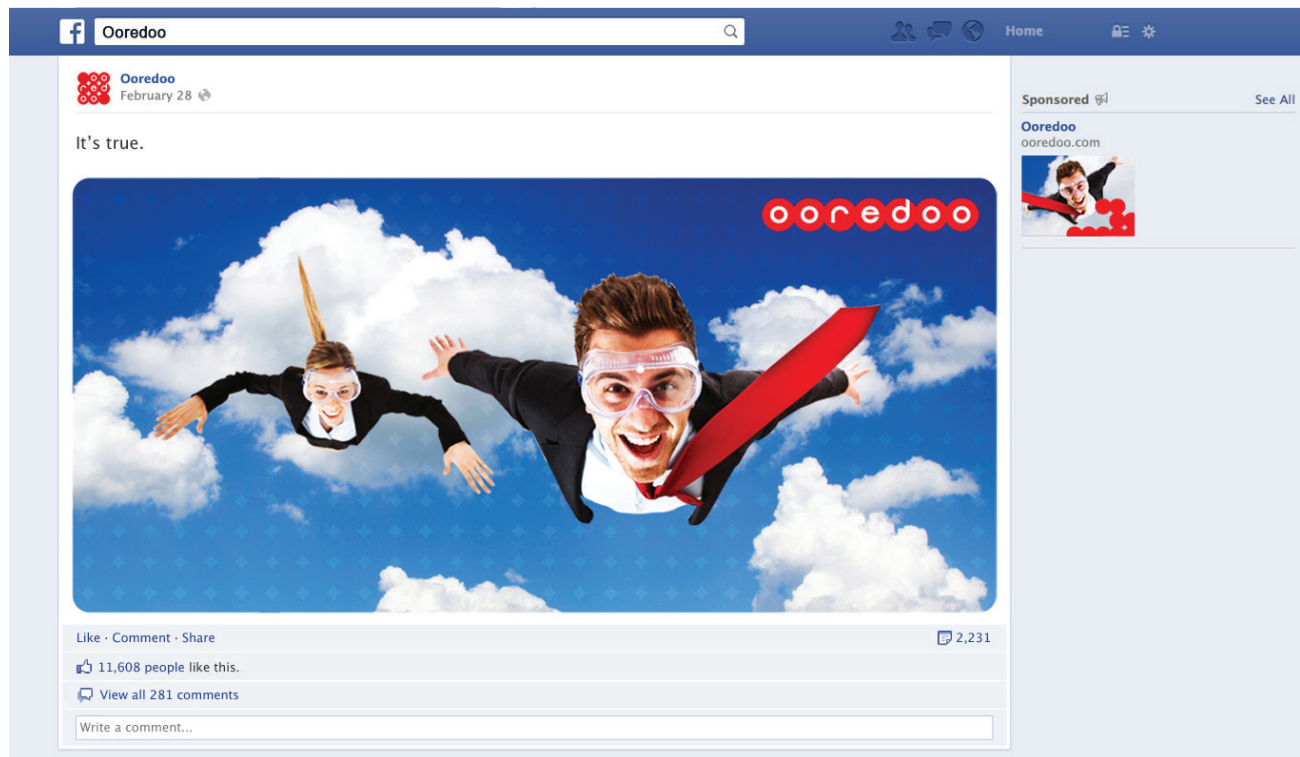

The look and feel of the Facebook page.

- **Highlighted post example**

Showcasing a business oriented Ooredoo post, using eye catching visual, inverted diamond grid and the horizontal Ooredoo logo.



Note:

Ads and sponsored stories in News Feed may not include images comprised of more than 20% text.

- **Ad example**

Showcasing a branded Ooredoo Facebook ad using the circle grid and an eye catching visual.

15.2 Facebook: Device Mockups

A preview of the Facebook page on different devices.



15.2 Facebook: Do's and Don'ts

For your reference, below are things that you have to keep in mind while creating your visuals.

Do's

1. Use the red stacked logo of Ooredoo as a profile picture at all times.
2. Keep in mind that there is a 20 pixel white space between the logo and the edge of the profile picture.
3. Make sure that the profile picture is 180 x 180 pixels.
4. Make sure that the cover image is 851 x 315 pixels.
5. Use a visual with an energetic composition and good lighting for cover images, ads and posts.
6. Make sure to use the horizontal Ooredoo logo on the posts if it is necessary.
7. Always optimise the size of the image for web and devices.
8. Review the grid tool: https://www.facebook.com/ads/tools/text_overlay
9. Use red elements on the covers images, ads and posts as often as possible.
10. Make sure to read the brand guidelines regarding the colours, diamond grid and the circle grid.
11. Make sure to read the Facebook guidelines.
12. Keep in mind that the models should be in business attire if you are targetting the business audience.

Don'ts

1. Do not use the Ooredoo horizontal logo for the profile picture.
2. Do not upload cover images that are smaller than 399 x 150 pixels. Images that are smaller than the optimum dimensions will get stretched and will look very low quality.
3. Don't hide content behind your profile picture.

Twitter: General design guide

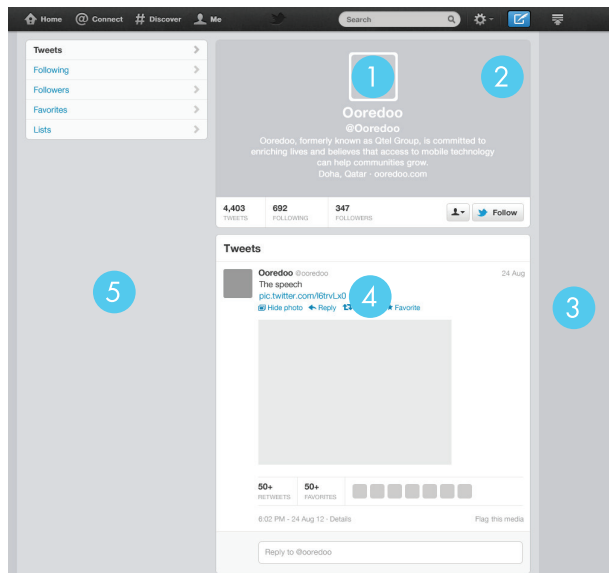

- 1 **Profile picture**
Dimension: 73 x 73 pixels
File format: JPG and PNG
Maximum File size: 2 megabytes
- 2 **Header image**
Dimensions: 520 x 260 pixels,
1252 x 626 pixels off Twitter
File format: JPG and PNG
Maximum File size: 5 megabytes
- 3 **Background**
Dimension: 1905 x 977 pixels
File format: JPG and PNG
Recommended File size: 2 megabytes
- 4 **Link**
Color: #ED1C24
- 5 **Overlay**
Color: #FFFFFF

Profile picture

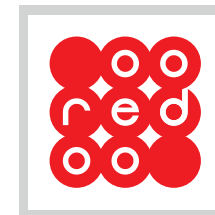

Use the red stacked logo of Ooredoo as a profile picture at all times.



Tips on image optimisation

Always “Save As” for web and devices. Do not forget to tick the “Convert to sRGB” box. The JPG image format is a lossy format, meaning you sacrifice picture quality to save file size. PNG files will be slightly larger, but will keep your details in-tact; which is very important if you will be using small text in your background.

For more information visit:

<https://support.twitter.com/>

15.3 Twitter: Content look and feel

The overall look and feel should use the Ooredoo design elements (please refer to the Ooredoo brand book for guidelines). Below are examples that you can refer to.

Header image



Background

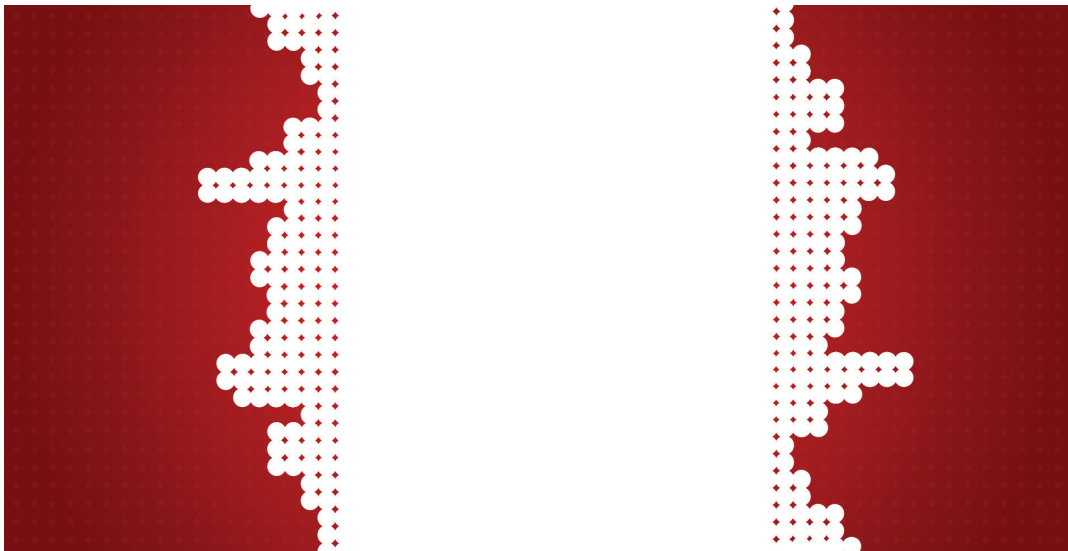

Link

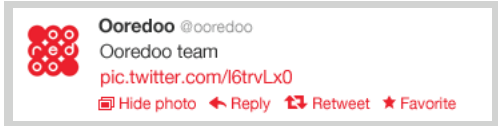

15.3 Twitter: Content look and feel example - Twitter page

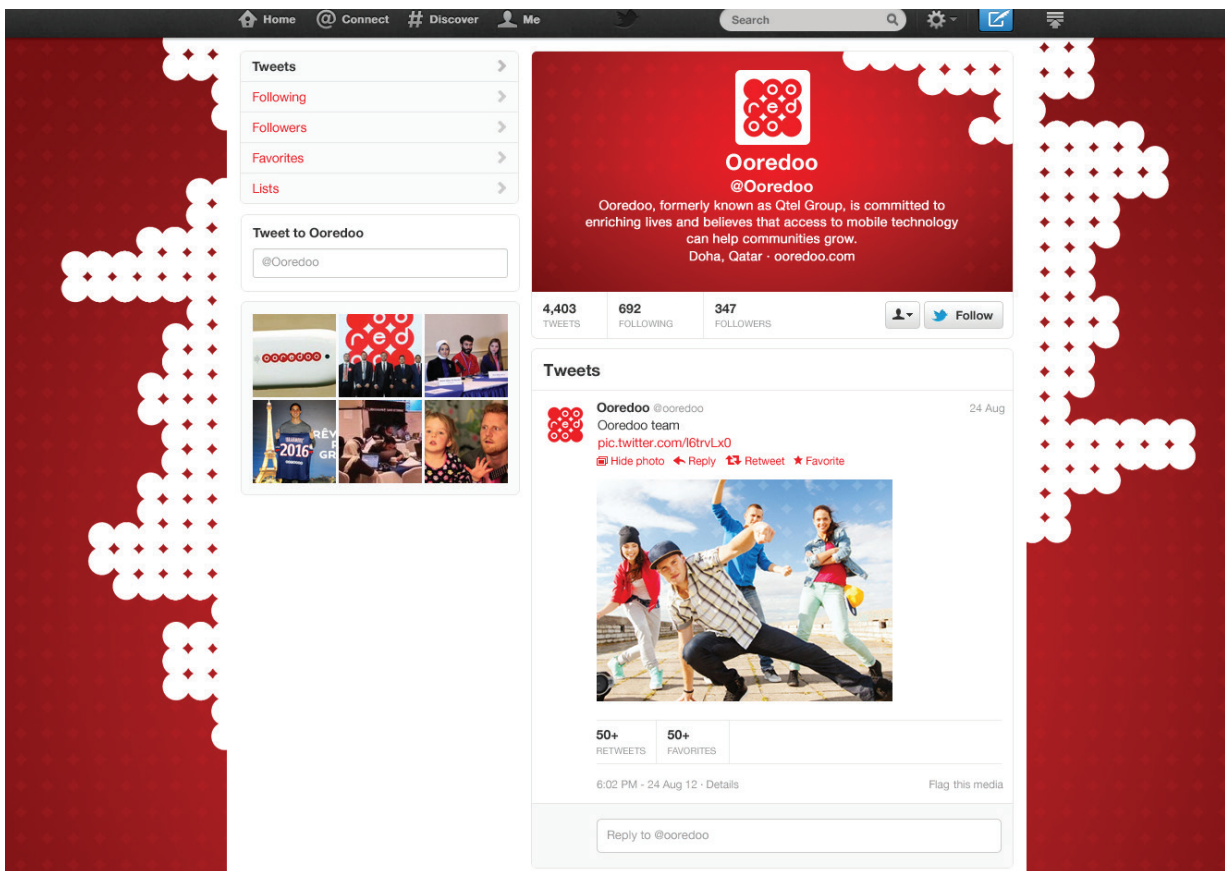

The look and feel of the Twitter page.

- **Header Image example**

Showcasing a branded Ooredoo Twitter header using the circle grid, inverted diamond grid and Ooredoo colours



Note:

Twitter adds a black gradient layer to the header regardless of your image.

- **Background example**

Showcasing a branded Ooredoo Twitter background using the circle grid, inverted diamond grid and Ooredoo colours.



Note:

The “cut off” rule of the inverted diamond grid and circle grid does not apply online.

15.3 Twitter: Device Mockups

A preview of the Twitter page on different devices.



15.3 Twitter: Do's and Don'ts

For your reference, below are things that you have to keep in mind while creating your visual.

Do's

1. Use the red stacked logo of Ooredoo as a profile picture at all times.
2. Keep in mind that there is a 20 pixel white space between the logo and the edge of the profile picture.
3. Make sure that the profile picture is 73 x 73 pixels.
4. Make sure that the header image is 520 x 260 pixels.
5. Always optimise the size of the image for web and devices.
6. Use red elements on the header images, overlay, links and background image as often as possible.
7. Make sure to read the brand guidelines regarding the colours, diamond grid and the circle grid.
8. Make sure to read the Twitter guidelines.

Don'ts

1. Do not use the horizontal logo of Ooredoo for the profile picture.
2. Do not forget that Twitter has a default black gradient overlay on the header image.
3. Do not use white elements behind the text on the header image.

15.4 Youtube: General design guide

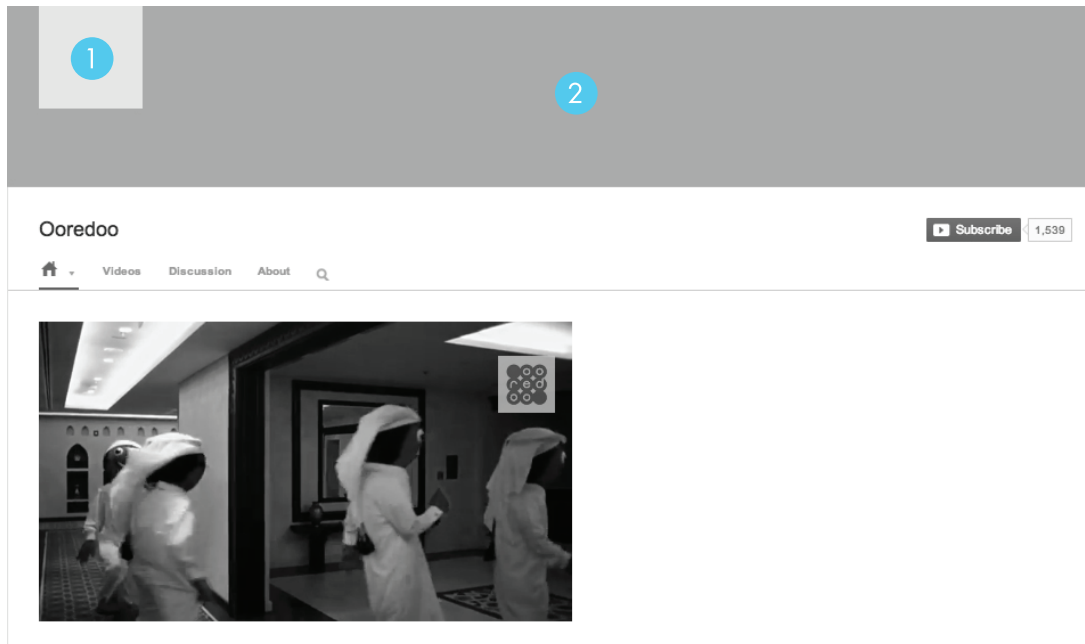

- 1** Channel icon
Dimension: 90 x 90 pixels
File format: JPG and PNG
Maximum file size: 1 megabyte

- 2** Channel art
Dimension: 2560 x 1440 pixels
(refer to the next page for specifications)
File format: JPG and PNG
Maximum file size: 2 megabytes

Profile picture

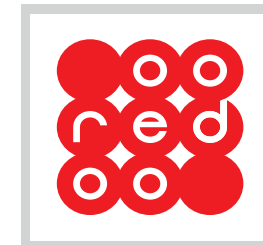

Use the red stacked logo of Ooredoo as a profile picture at all times. Add a 20 pixel white space between the logo and the edge.



Tips on image size optimisation

Always “Save As” for web and devices. Do not forget to tick the “Convert to sRGB” box. The JPG image format is a lossy format, meaning you sacrifice picture quality to save file size. PNG files will be slightly larger, but will keep your details in-tact; which is very important if you will be using small text in your background.

For more information visit:

https://support.google.com/youtube/topic/2976171?hl=en&ref_topic=3030597

15.4 Youtube: General design guide

Full specifications for the Channel Art to follow is in the section below.



- 1 Text and logo safe area
Dimension: 1546 x 423 pixels
- 2 TV
Dimension: 2560 x 1440 pixels
- 3 Desktop maximum
Dimension: 2560 x 423 pixels
- 4 Desktop minimum and mobile
Dimension: 1546 x 423 pixels
- 5 Tablet
Dimension: 1855 x 423 pixels

15.4 Youtube: Content look and feel

The overall look and feel of the visuals with the use of Ooredoo design elements (please refer to the Ooredoo brand book for guidelines). Below are examples that you can refer to.

Channel Art

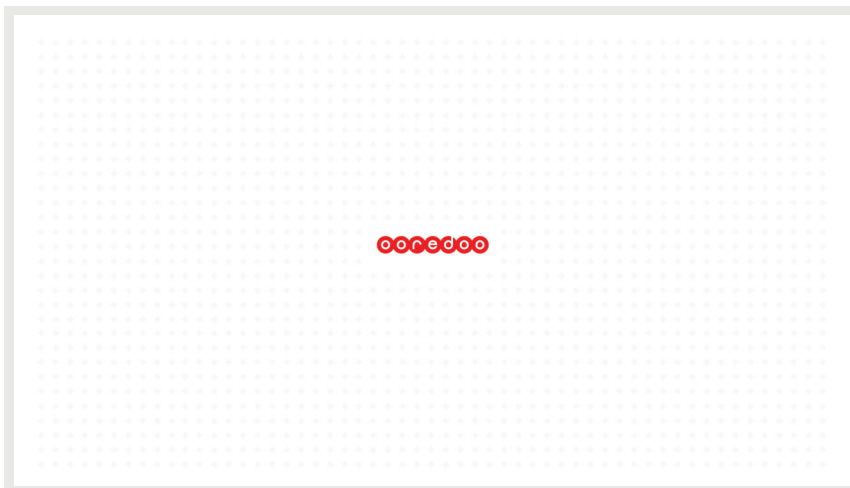

15.4 Youtube: Content look and feel example - YouTube page

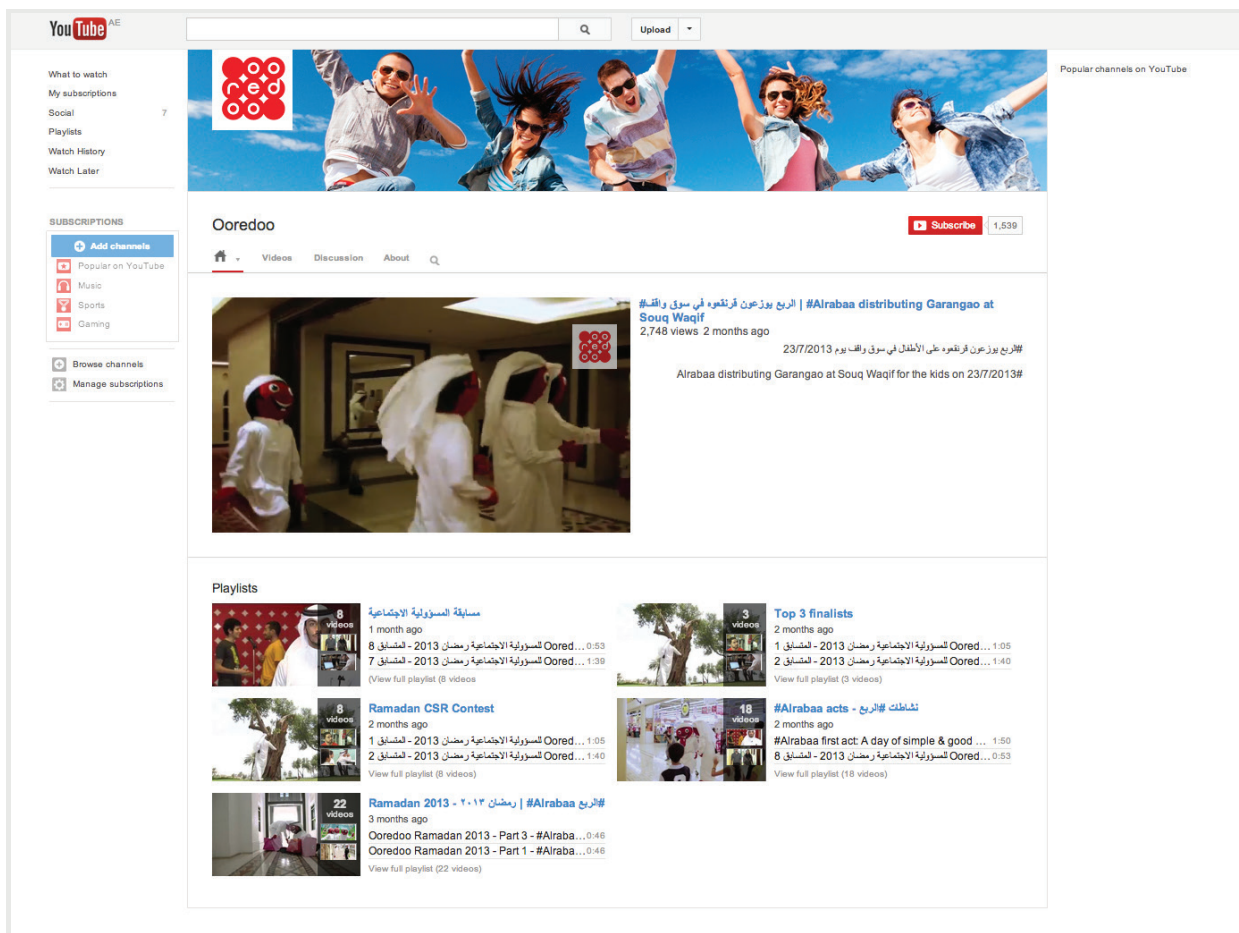

The look and feel of the YouTube page.

- **Channel art example**
Showcasing a branded Ooredoo YouTube channel art using the inverted diamond grid, Ooredoo logo and Ooredoo colours.



Note:
The “cut off” rule of the inverted diamond grid and circle grid does not apply online.

15.4 Youtube: Device Mockups

A preview of the YouTube page on different devices.



15.4 Youtube: Do's and Don'ts

For your reference, below are things that you have to keep in mind while creating your visuals.

Do's

1. Use the red stacked logo of Ooredoo as a profile picture at all times.
2. Keep in mind that there is a 20 pixel white space between the logo and the edge of the profile picture.
3. Make sure that the profile picture is 90 x 90 pixels.
4. Make sure to consult the channel art specification before you start working on it.
5. Always optimise the size of the image for web and devices.
6. Use red elements on the header images, overlay, links and background image as often as possible.
7. Make sure to read the brand guidelines regarding the colours, diamond grid and the circle grid.
8. Make sure to read the YouTube guidelines.

Don'ts

1. Do not use the horizontal logo of Ooredoo for for the profile picture.
2. Do not forget that the channel art changes depending on the resolution of your screen.

15.5 Pinterest: General design guide

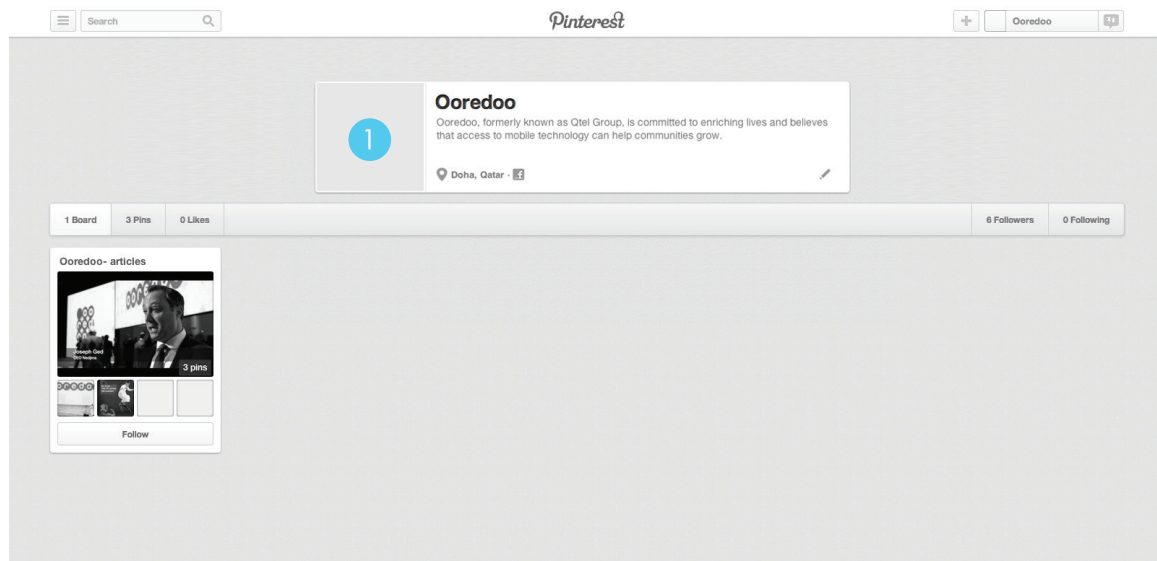

- 1 Profile picture
Dimension: 165 x 165 pixels
File format: JPG and PNG
Recommended file size: 100 kilobytes

Profile picture

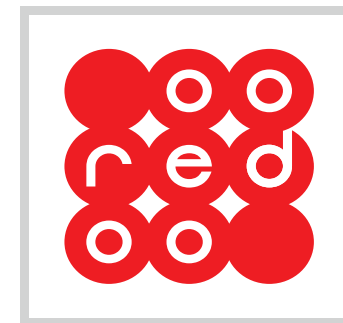

Use the red stacked logo of Ooredoo as a profile picture at all times. Add a 20 pixel white space between the logo and the edge.



Tips on image size optimisation

Always “Save As” for web and devices. Do not forget to tick the “Convert to sRGB” box. The JPG image format is a lossy format, meaning you sacrifice picture quality to save file size. PNG files will be slightly larger, but will keep your details in-tact; which is very important if you will be using small text in your background.

For more information visit:

<https://help.pinterest.com/home>

15.5 Pinterest: Content look and feel example - Pinterest page

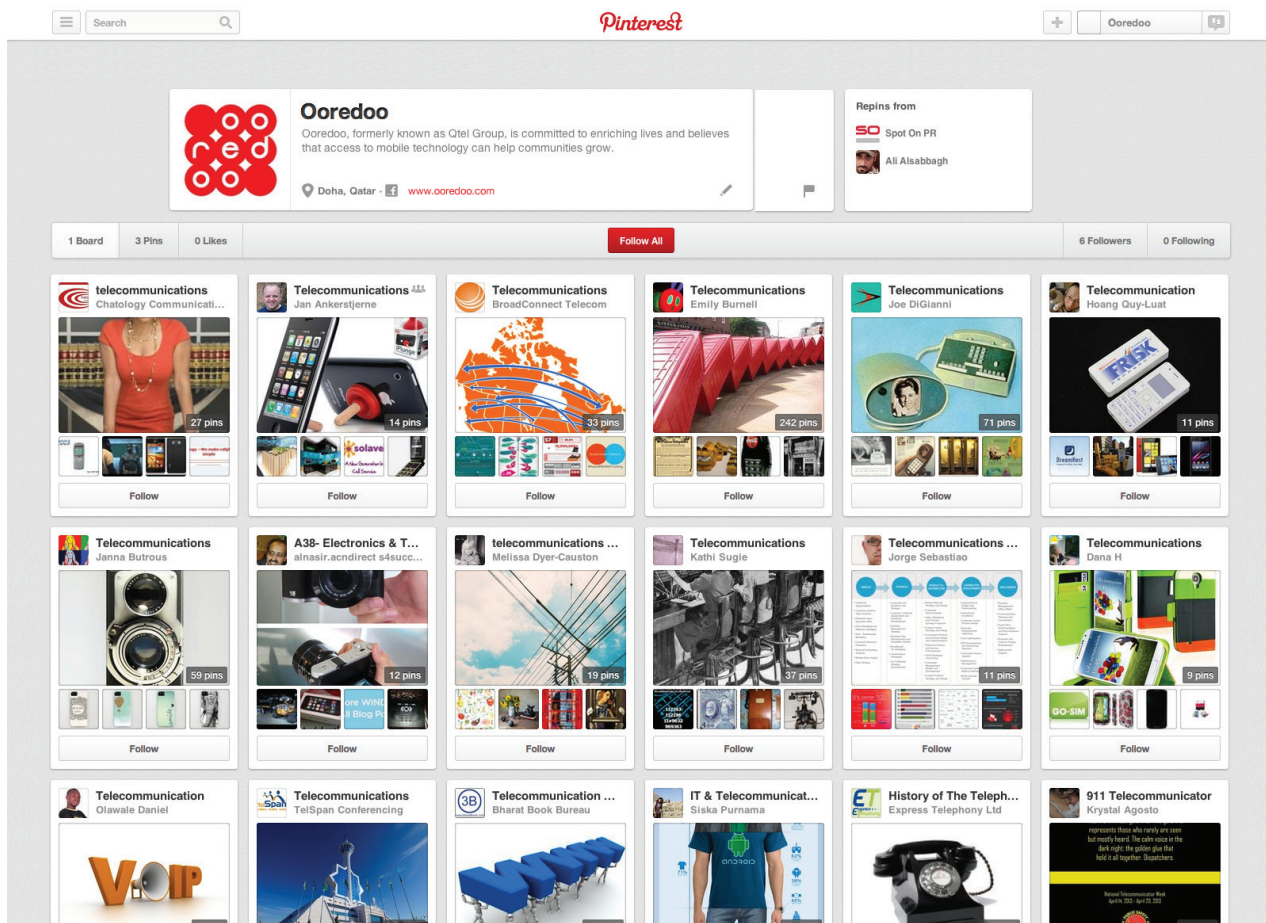

The look and feel of the Pinterest page.

15.5 Pinterest: Device Mockups

A preview of the Pinterest page on different devices.



15.5 Pinterest: Do's and Don'ts

For your reference, below are things that you have to keep in mind while creating your visuals.

Do's

1. Use the red stacked logo of Ooredoo as a profile picture at all times.
2. Keep in mind that there is a 20 pixel white space between the logo and the edge of the profile picture.
3. Make sure that the profile picture is 165 x 165 pixels.
4. Always optimise the image for web and devices.
5. Make sure to read the Pinterest guidelines.

Don'ts

1. Do not use the horizontal logo of Ooredoo for for the profile picture.

15.6 Instagram: General design guide - Mobile



- 1 Profile picture
Dimension: 140 x 140 pixels
File format: JPG and PNG
Recommended file size: 100 kilobytes



Make sure that the stacked logo is within the safe area.

- 2 Image post
Dimension: 612 x 612 pixels
File format: JPG and PNG
Recommended file size: 500 kilobytes

- 3 Video post
Dimension: 640 x 640 pixels
File format: MOV and MP4
Duration: 15 seconds

Profile picture

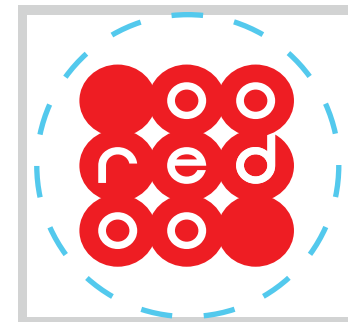

Use the red stacked logo of Ooredoo as a profile picture at all times. Add a 20 pixel white space between the logo and the edge.



Tips on image size optimisation

Always "Save As" for web and devices. Do not forget to tick the "Convert to sRGB" box. The JPG image format is a lossy format, meaning you sacrifice picture quality to save file size. PNG files will be slightly larger, but will keep your details in-tact; which is very important if you will be using small text in your background.

For more information visit:

<http://help.instagram.com/116836975134193/>

15.6 Instagram: General design guide - Web

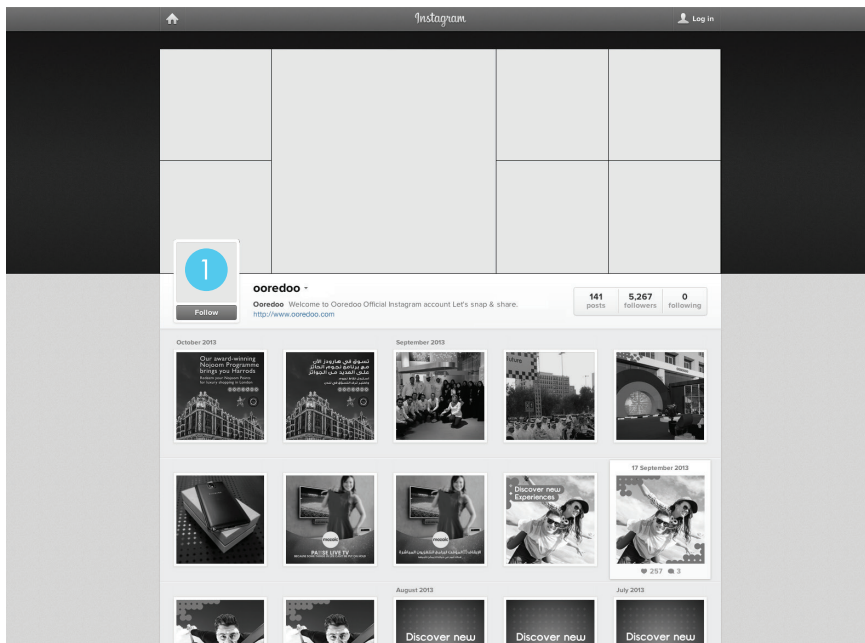

- Profile picture**
 Dimension: 140 x 140 pixels
 File format: JPG and PNG
 Recommended file size: 100 kilobytes

Profile picture

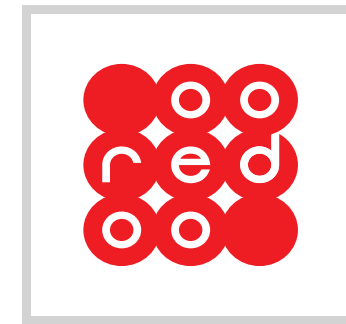

Use the red stacked logo of Ooredoo as a profile picture at all times.



Tips on image optimization

Always save for web and devices. The JPG image format is a lossy format, meaning you sacrifice picture quality to save file size. PNG files will be slightly larger, but will keep your details in-tact; which is VERY important if you will be using small text in your background.

For more information visit:

<http://help.instagram.com/116836975134193/>

15.6 Instagram: Content look and feel

The overall look and feel of the visuals with the use of Ooredoo design elements (please refer to the Ooredoo brand book for guidelines). Below are examples that you can refer to.

Image post



15.6 Instagram: Content look and feel example - Instagram pages

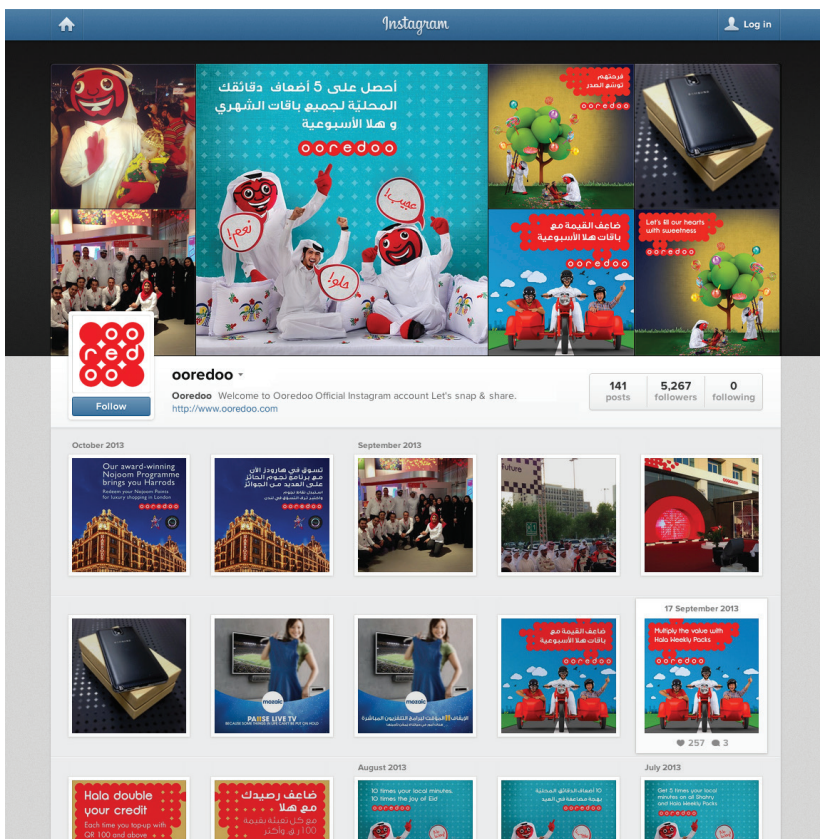

The look and feel of the Instagram pages.

15.6 Instagram: Device Mockups

A preview of the Instagram page on different devices.



15.6 Instagram: Do's and Don'ts

For your reference, below are things that you have to keep in mind while creating your visuals.

Do's

1. Use the red stacked logo of Ooredoo as a profile picture at all times.
2. Keep in mind that there is a 20 pixel white space between the logo and the edge of the profile picture.
3. Make sure that the profile picture is 140 x 140 pixels.
4. Make sure that the Ooredoo stacked logo is within the safe area.
4. Always optimise the image for web and devices.
5. Make sure to read the Instagram guidelines.

Don'ts

1. Do not use the horizontal logo of Ooredoo for for the profile picture.

15.7 Google +: General design guide

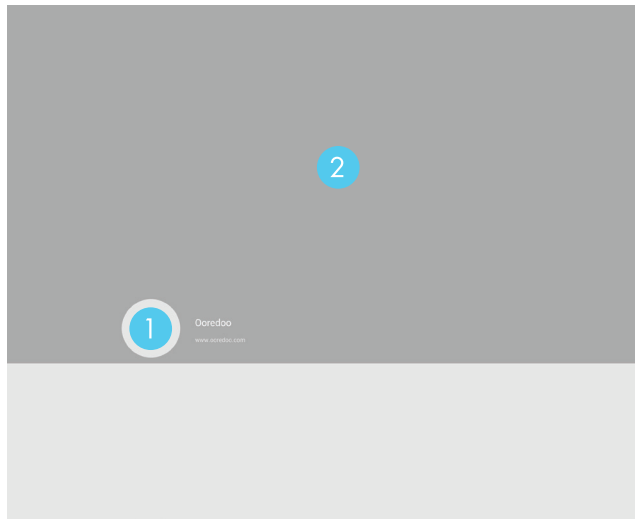

- 1 Profile picture**
 Dimension: 250 x 250 pixels
 File format: JPG and PNG
 Recommended file size: 500 kilobytes



Make sure that the stacked logo is within the safe area.

- 2 Cover photo**
 Dimension: 2120 x 1192 pixels
 File format: JPG and PNG
 Recommended file size: 2 megabytes

Profile picture

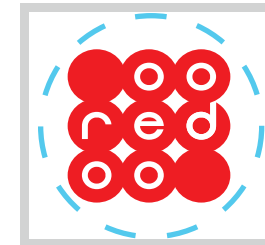

Use the red stacked logo of Ooredoo as a profile picture at all times. Add a 20 pixel white space between the logo and the edge.



Tips on image size optimisation

Always "Save As" for web and devices. Do not forget to tick the "Convert to sRGB" box. The JPG image format is a lossy format, meaning you sacrifice picture quality to save file size. PNG files will be slightly larger, but will keep your details in-tact; which is very important if you will be using small text in your background.

For more information visit:

<https://support.google.com/plus/?hl=en#topic=3049661>

15.7 Google +: Content look and feel

The overall look and feel should use the ooredoo design elements (please refer to the Ooredoo brand book for guidelines). Below are examples that you can refer to.

Cover photo - Consumer



15.7 Google +: Content look and feel example - Google + page



The look and feel of the Google + page.

- **Cover photo example**

Showcasing a branded Ooredoo Google + cover photo using the circle grid, eye catching visual and the inverted diamond grid.



Note:

Google + adds a black gradient layer to the header regardless of your image. The profile photo lays over the cover photo, so text and other important details should not be in the bottom area of the photo.

15.7 Google +: Device Mockups

A preview of the Google + page on different devices.



15.7 Google +: Do's and Don'ts

For your reference, below are things that you have to keep in mind while creating your visual.

Do's

1. Use the red stacked logo of Ooredoo as a profile picture at all times.
2. Keep in mind that there is a 20 pixel white space between the logo and the edge of the profile picture.
3. Make sure that the profile picture is 250 x 250 pixels.
4. Make sure that the cover photo is 2120 x 1192 pixels.
5. Always optimise the size of the image for web and devices.
6. Use red elements on the header images, overlay, links and background image as often as possible.
7. Make sure to read the brand guidelines regarding the colours, diamond grid and the circle grid.
8. Make sure to read the Google + guidelines.

Don'ts

1. Do not use the horizontal logo of Ooredoo for for the profile picture.
2. Do not forget that the channel art changes depending on the resolution of your screen.
3. Do not add text and other important details in the bottom area of the cover photo.

15.8 LinkedIn: General design guide

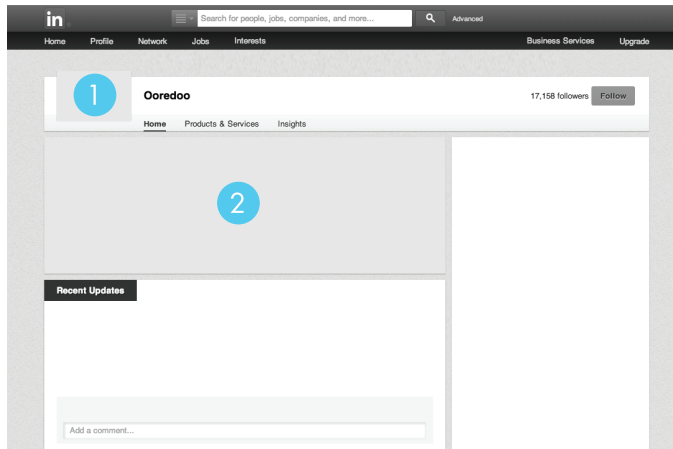

1 Profile picture
 Dimension: 100 x 60 pixels
 File format: JPG and PNG
 Maximum file size: 4 megabytes

2 Cover photo
 Dimension: 646 x 220 pixels
 File format: JPG and PNG
 Maximum file size: 4 megabytes

3 Company product/services image
 Dimension: 100 x 80 pixels
 File format: JPG, PNG and GIF
 Maximum file size: 2 megabytes

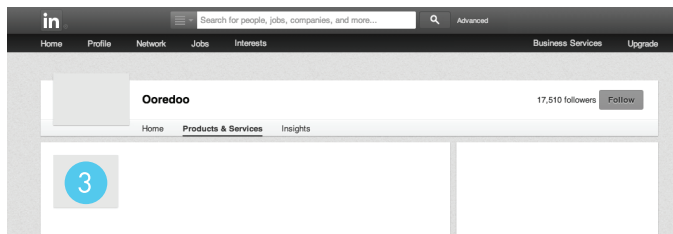

Profile picture



Use the red stacked logo of Ooredoo as a profile picture at all times. Add a 20 pixel white space between the logo and the edge.



Tips on image size optimisation

Always "Save As" for web and devices. Do not forget to tick the "Convert to sRGB" box. The JPG image format is a lossy format, meaning you sacrifice picture quality to save file size. PNG files will be slightly larger, but will keep your details in-tact; which is very important if you will be using small text in your background.

For more information visit:

<http://help.linkedin.com/>

15.8 LinkedIn: Content look and feel

The overall look and feel for LinkedIn is business oriented (please refer to the Ooredoo brand book for guidelines). Below are examples that you can refer to.

Cover photo



Company products & services image



15.8 LinkedIn: Content look and feel example - LinkedIn profile page

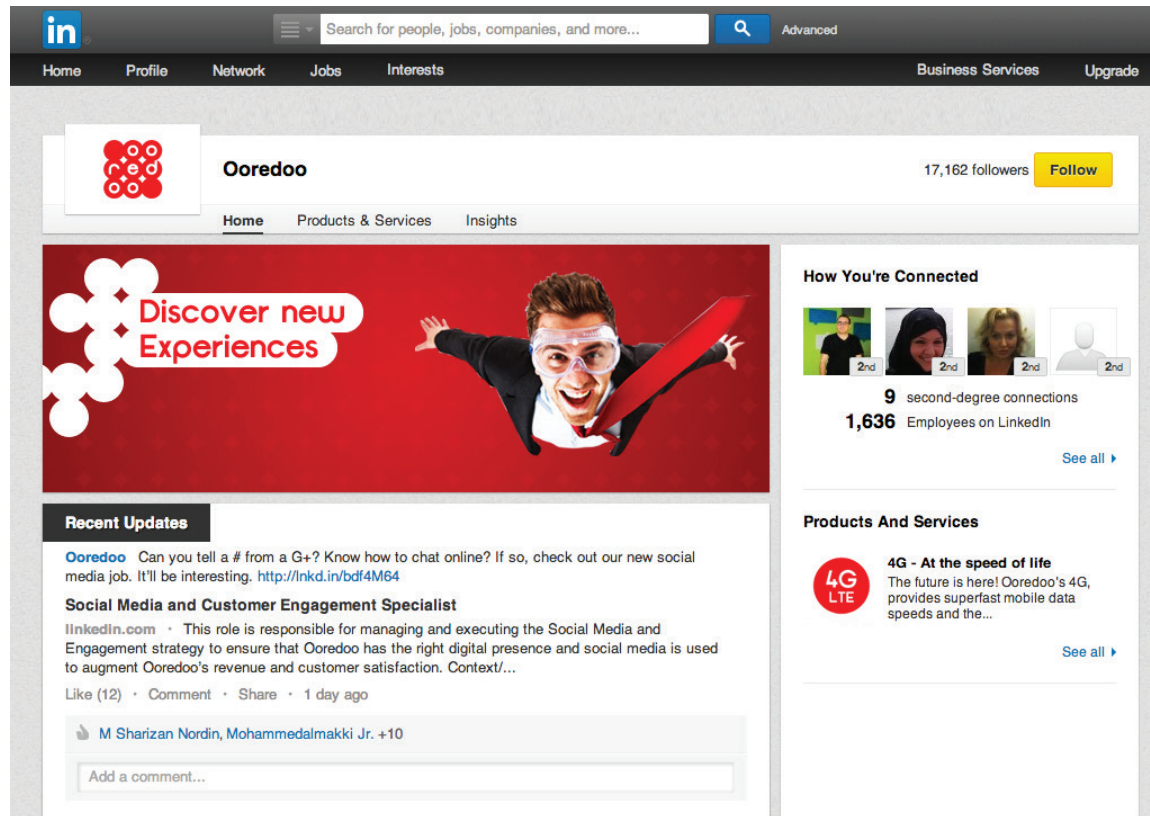

The look and feel of the LinkedIn page.

- Cover photo example
Showcasing a branded Ooredoo LinkedIn cover photo using the circle grid, eye catching visual, inverted diamond grid, background gradient, and Ooredoo font.

15.8 LinkedIn: Content look and feel example - LinkedIn products & services page

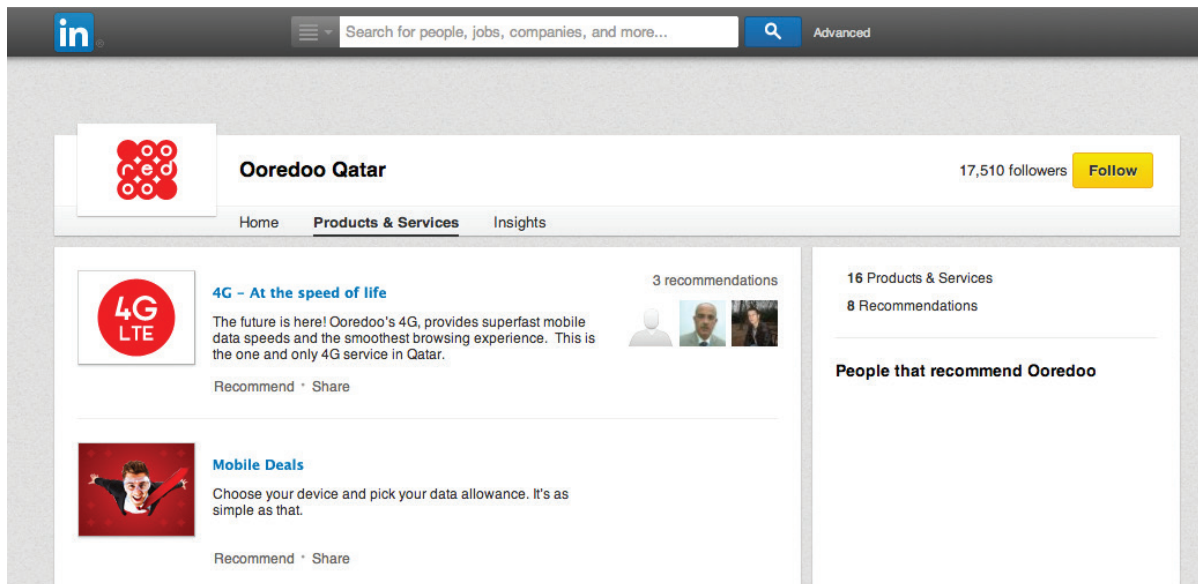

The look and feel of the LinkedIn products & services page.

- **Company products & services example**
Showcasing a branded Ooredoo LinkedIn company products & services photo using eye catching visual, inverted diamond grid, background gradient, and Ooredoo font.

15.8 LinkedIn: Device Mockups

A preview of the LinkedIn page on different devices.

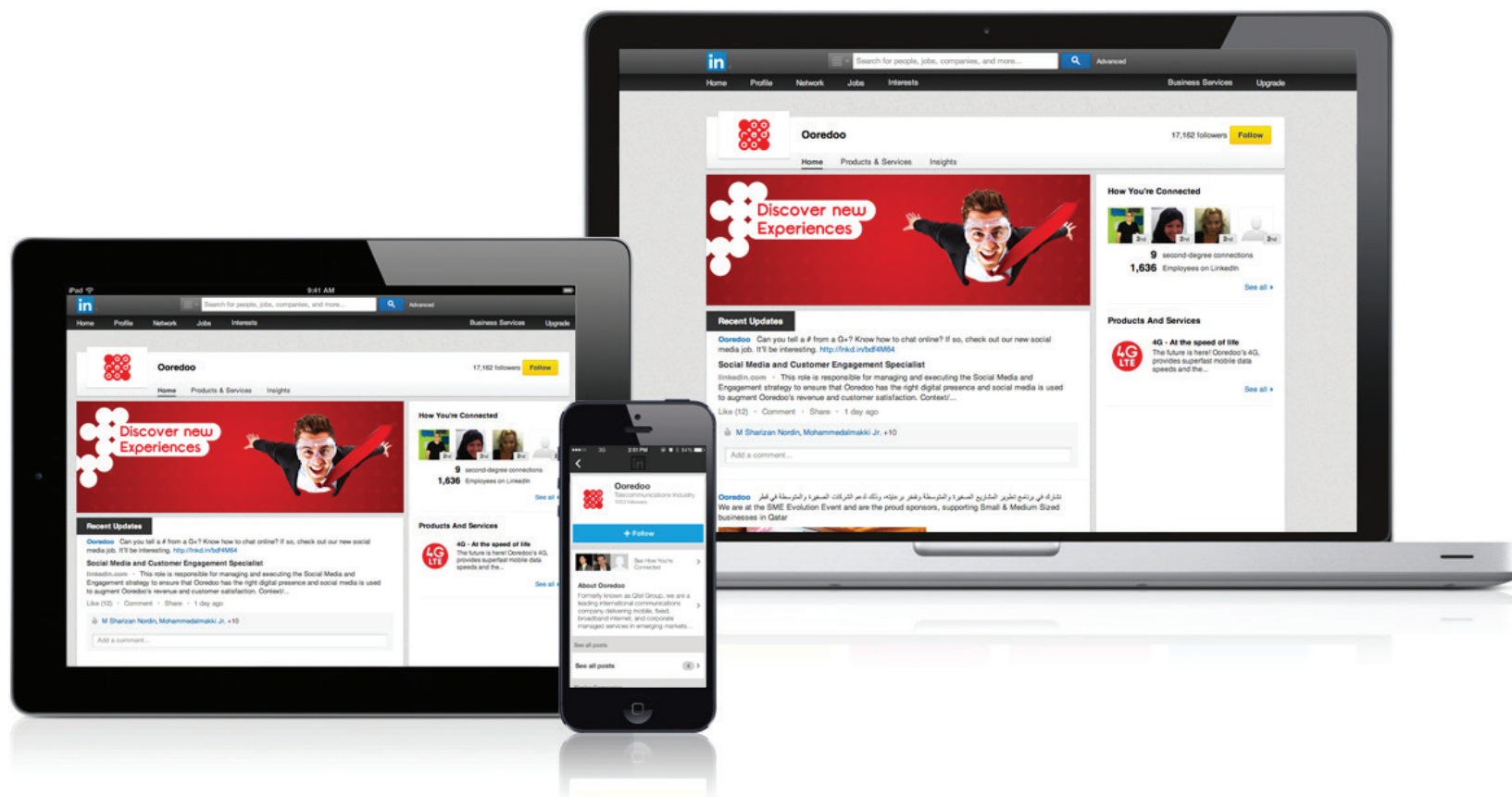

15.8 LinkedIn: Do's and Don'ts

For your reference, below are things that you have to keep in mind while creating your visual.

Do's

1. Use the red stacked logo of Ooredoo as a profile picture at all times.
2. Keep in mind that there is a 20 pixel white space between the logo and the edge of the profile picture.
3. Make sure that the profile picture is 100 x 60 pixels.
4. Make sure that the header image is 646 x 220 pixels.
5. Make sure that the company products & services image is 100x80 pixels.
6. Always optimise the image for web and devices.
7. Use red elements on the header images, overlay, links and background image as often as possible.
8. Keep in mind that the models should be in business attire.
9. Make sure to consult the brand guidelines regarding the colours, diamond grid and the circle grid.
10. Make sure to read the Linked In guidelines.

Don'ts

1. Do not use the horizontal logo of Ooredoo for for the profile picture.
2. Do not change the color of the stacked logo other than white and Ooredoo red.

15.9 Tumblr: General design guide

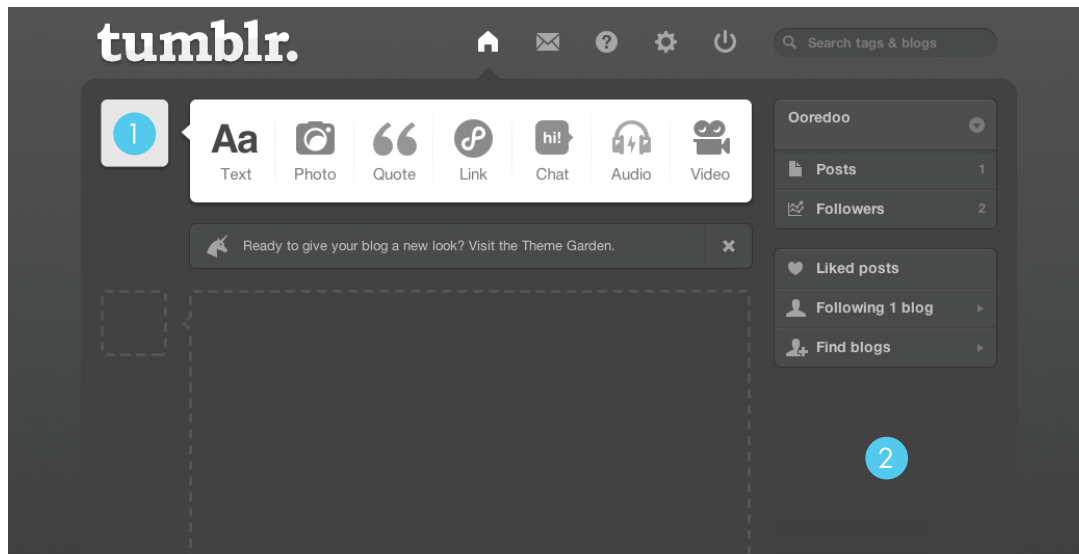

- 1 Avatar**
Dimension: 128 x 128 pixels
File format: JPG and PNG
Maximum file size: 1 megabyte

- 2 Layout**
Type: Custom layout (will be discussed next page).

Profile picture

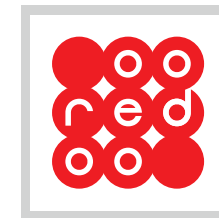

Use the red stacked logo of Ooredoo as a profile picture at all times. Add a 20 pixel white space between the logo and the edge.



Tips on image size optimisation

Always "Save As" for web and devices. Do not forget to tick the "Convert to sRGB" box. The JPG image format is a lossy format, meaning you sacrifice picture quality to save file size. PNG files will be slightly larger, but will keep your details in-tact; which is very important if you will be using small text in your background.

For more information visit:

<http://www.tumblr.com/help>

15.9 Tumblr: Custom layout look and feel example - Tumblr page

It is best if we create a totally customised look for the Ooredoo Tumblr page, it makes it far more attractive, on-brand and more freedom when it comes to content creation. Below is an example of the Ooredoo Tumblr page.

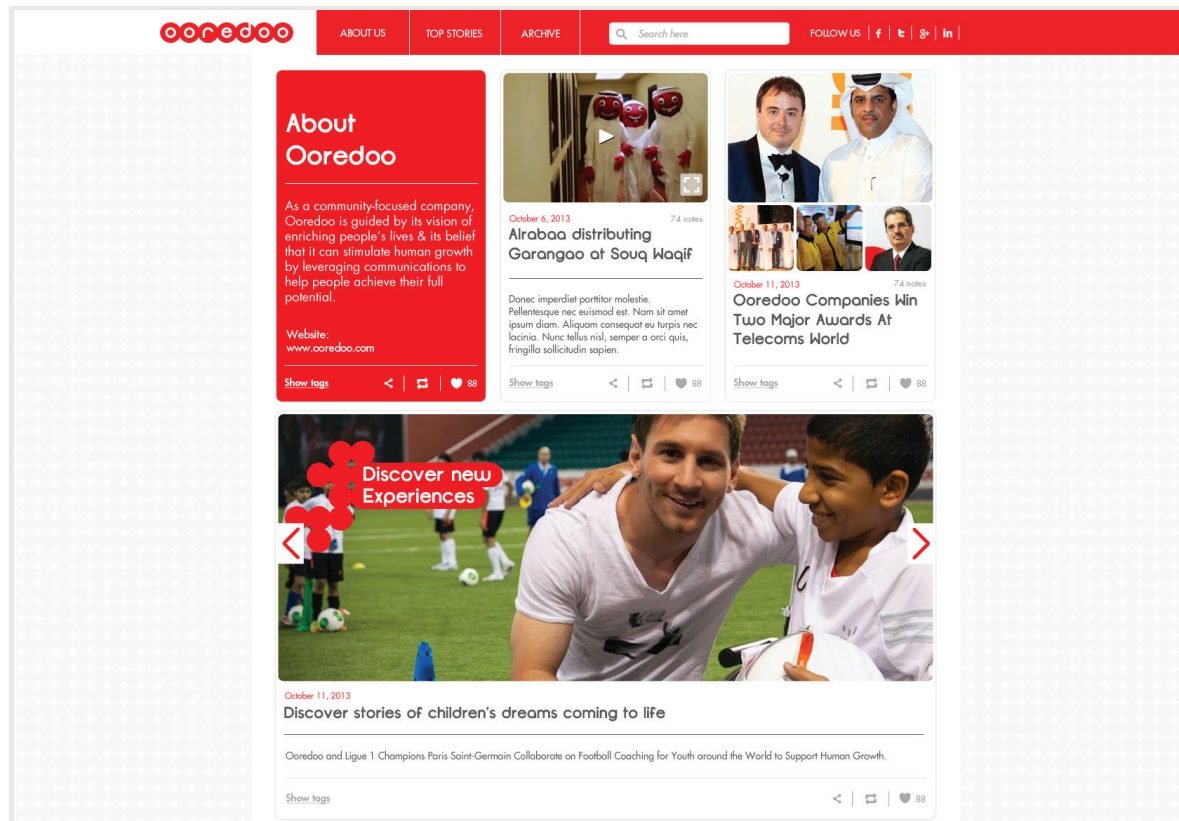

The look and feel of the Tumblr page.

- Home page example
Showcasing a branded and responsive Ooredoo Tumblr page.



Note:

Widgets that would add more interaction to the page could be added.

15.9 Tumblr: Custom layout look and feel example - Tumblr page

Below is an example of the Ooredoo Tumblr page.

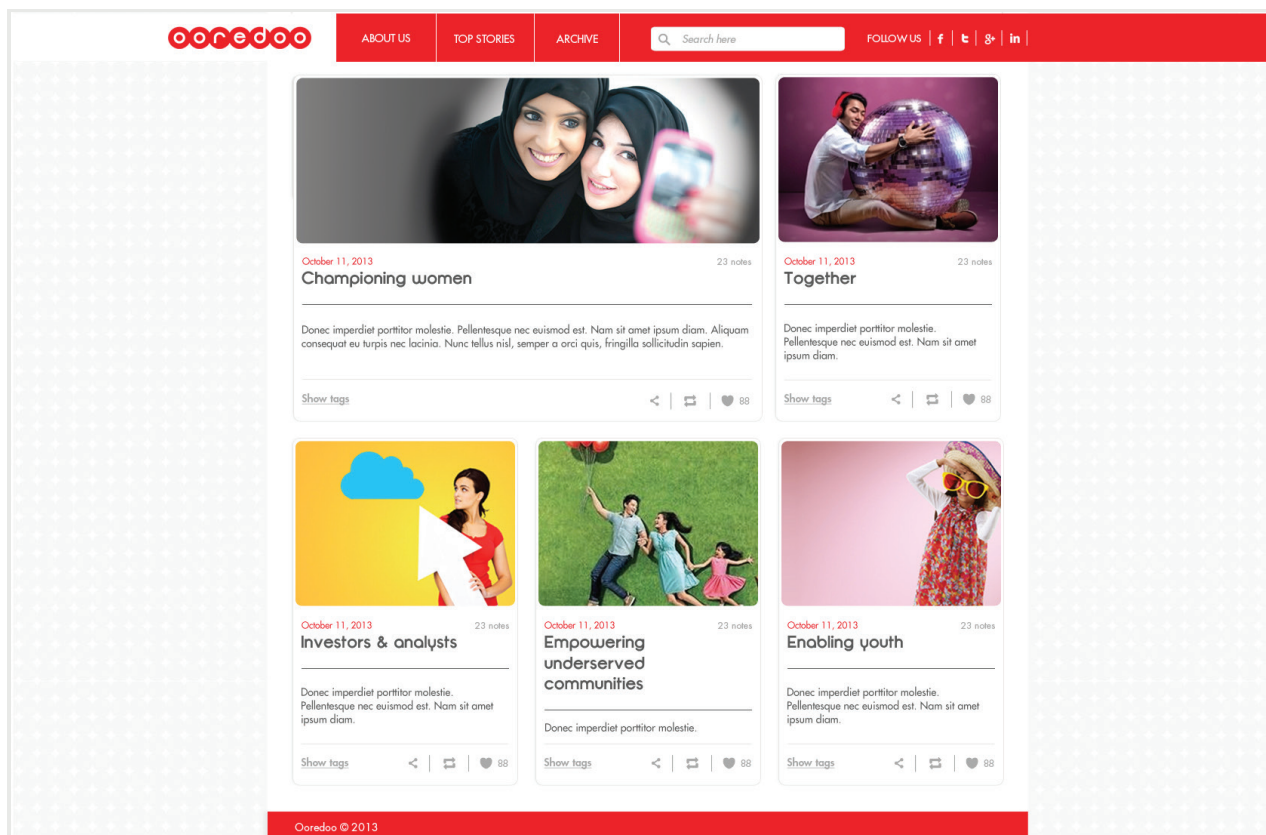

The look and feel of the Tumblr page.

- Home page example
Showcasing a branded and responsive Ooredoo Tumblr page.

15.9 Tumblr: Custom layout look and feel example - Tumblr inner page

Below is an example of the Ooredoo Tumblr inner page.



The look and feel of the Tumblr inner page.

- Inner page example
Showcasing a social media integrated Tumblr inner page.

15.9 Tumblr: Custom layout look and feel example - Tumblr inner page

Below is an example of the Ooredoo Tumblr inner page.

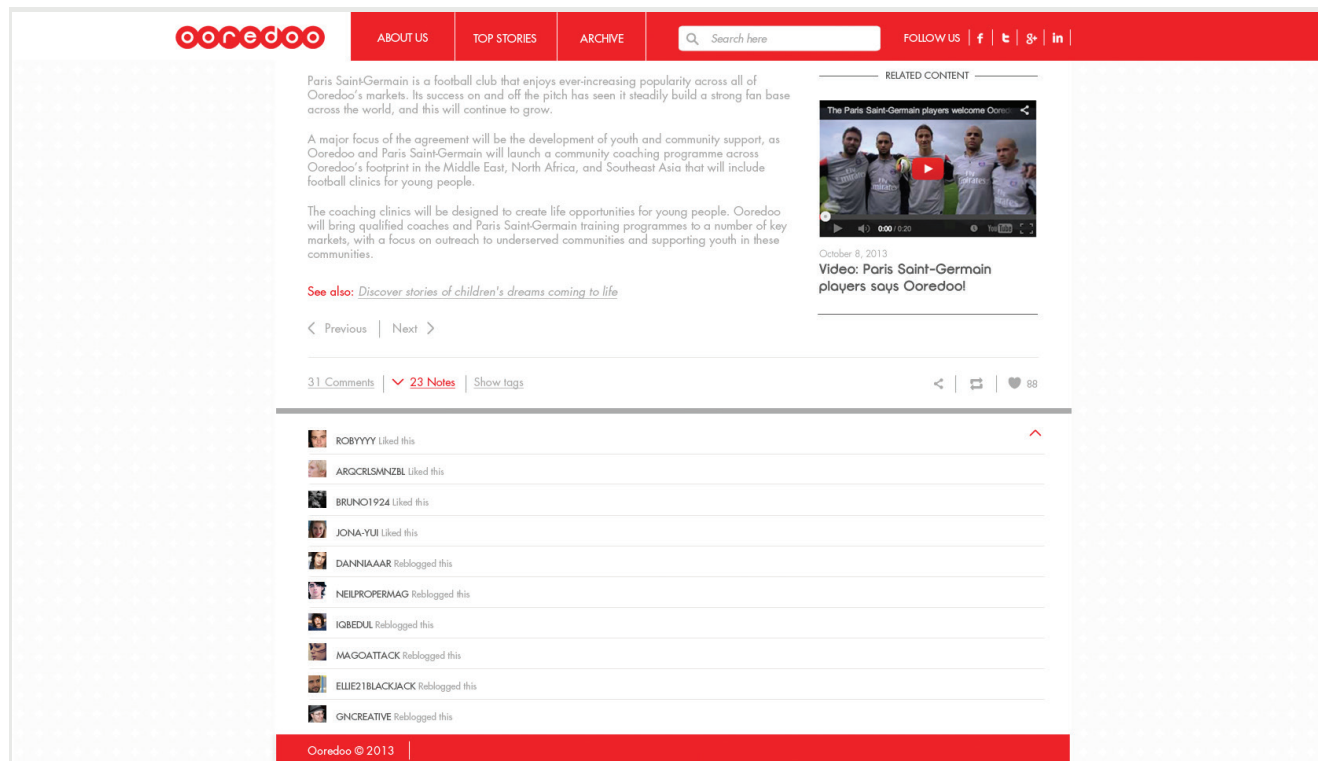

The look and feel of the Tumblr inner page.

- Inner page example
Showcasing user activity to the post through notes and comments.

15.9 Tumblr: Device Mockups

A preview of the Tumblr page on different devices.



15.9 Tumblr: Do's and Don'ts

For your reference, below are things that you have to keep in mind while creating your visuals.

Do's

1. Use the red stacked logo of Ooredoo as a profile picture at all times.
2. Keep in mind that there is a 20 pixel white space between the logo and the edge of the profile picture.
3. Make sure that the profile picture is 128 x 128 pixels.
4. Use a custom layout.
5. Always optimise the image for web and devices.
6. Make sure to make it responsive.
7. Make sure to consult the brand guidelines regarding the colours, diamond grid and the circle grid.
8. Make sure to read the Tumblr guidelines.

Don'ts

1. Do not use the horizontal logo of Ooredoo for for the profile picture.
2. Do not change the color of the stacked logo other than white and Ooredoo red.
3. Do not use a standard layout.

Social media management guidelines

- 16.1 Introduction
- 16.2 Channel set up
- 16.3 Content strategy
- 16.4 Hashtag planning
- 16.5 Paid, owned and earned
- 16.6 Paid media approach
- 16.7 Reporting
- 16.8 Influencer engagement
- 16.9 Applications
- 16.10 Best practices
- 16.11 Support links

16.1 Introduction

Social media platforms are changing the way we work, offering us new ways to build collaborative relationships with our colleagues, customers and the world at large. These platforms provide us with a valuable opportunity to meaningfully engage in conversations about the work we do at Ooredoo. To help us maximize the opportunities that the social space presents we have developed a set of guidelines to ensure that Ooredoo's brand equity is effectively translated and leveraged across all platforms and markets.

Note:

It is important to remember that we are living through a fundamental shift in the way we relate to our customers. We need to be comfortable and flexible enough to navigate through this change. As change is our only constant in this space. Accordingly this guideline document will be updated on a regular basis.

16.2 Channel set up: Channel Relevance







There are hundreds of social networking sites that exist online today, however not all of them are necessarily relevant to us. So we have developed a list of the key networks that we should be looking at today, based on audience behaviours and propensity towards interacting with brands on these channels.

The list, below, gives us a better idea of the type of audience that we can expect to find on each channel; what the strategic relevance of each is and the estimated level of effort it would take manage the channel.

Effort ranking based on a scale of 1-10, where 1 is minimal and 10 is maximum.

Note: The list will be under constant review as new channels and trends emerge in this ever-evolving space.

16.2

Social Networks	Target Audience	Purpose and activities	Effort
	Masses	Facebook is often seen as the main social communication and advertising channel for all social activities. Acting as the connecting platform, it can bring together content from across all the other channels, such as rich media from YouTube, Instagram feed tab, Event and Google+ Hangout invites.	6
	Media and opinion leaders	Playing to its strengths, Twitter is best used as the main news and customer care channel. Recommended for featuring live coverage, first release of updates, teasers, and links to interviews, articles and website.	8
	Niche communities	Provides us with the opportunity to express the personality of the brand by sharing powerful images and creative points of view that reinforce the Ooredoo brand personality.	6
	Everyone	The world's second largest search engine provides opportunities to reach and engage a broad audience. Online videos should answer 2 main audience expectations: Entertainment and product information.	4
	Professional	Think of your Page as an extension of your business website within LinkedIn. Use it to position Ooredoo as a thought leader by sharing industry articles and interviews. Showcase products and services, research papers and job opportunities.	
	Tech savvy	The social extension of Google makes a pronounced impact on search engine optimization (SEO) unlike other social networks. Ensure to complete all profile information with links back to your website and don't forget to use keywords.	3
	Creative	Used effectively Pinterest can provide you with more backlinks to your website, a crucial SEO ranking signal thereby increasing your visibility. Pinterest is an excellent way of showcasing your products and of demonstrating your passion and expertise in a particular area.	4
	Youthful	Micro blogging platform for sharing short-form, multimedia content. Optimal platform for content to spread quickly (viral). In-links from the platform provide SEO benefits.	5

16.2 Channel set up: Usernames

In the rapidly expanding social media sphere there are many opportunities and challenges when it comes to setting up properties in this space. Elements including usernames, URLs, avatars are all critical digital assets that protect and promote Ooredoo's initiatives online.

Usernames function in much the same way as domain names - they should be easy to remember.



Users navigate social spaces by searching for or directly entering the username of the brand they are looking for. A clear and consistent naming convention provides trust and a positive brand experience by ensuring that the users' content expectations are met. For a global brand like Ooredoo with multiple properties in the social sphere we need to ensure users find the most relevant Page or Profile for their needs whether that is a purely customer service channel or the right country for them.

Certain social media sites may have a maximum or minimum character length for usernames. For example due to the limited number of characters allowed in a tweet, a user will be discouraged to mention you in their tweet if your twitter handle is too long, so it is best to keep the Twitter handle as short as possible.

Exceptions will need to be made when the combination of Ooredoo and the market name or acronym result in another meaning. For example @Ooredoomm results in a negative meaning – doom. In this case you will need use an underscore for Twitter handles, as seen in examples below.

Protection being proactive can help protect Ooredoo's reputation on social channels by preventing other users registering infringing account usernames or handles that are likely to be visited by potential customers. This can be prevented by registering Pages with close variations – including varieties with hyphens, acronyms, brand name and market or product keywords – and keeping these Pages unpublished/inactive and safely reserved.

16.2

SN	Username	Handle	URL	Solutions
	Ooredoo Qatar	-	www.facebook.com/ooredooqatar	
	Ooredoo Myanmar	Ooredoomm	www.twitter.com/ooredoomm	Ooredoo_mm
	Ooredoo Qatar	OoredooQatar	www.instagram.com/ooredooqatar	

16.2 Channel set up: What to do if your username has already been registered by another user?

There are two cases where this may occur:

A. The user has the same name for their personal account and is not by intention impersonating Ooredoo

- In this case, the first step would be to reach out to the user by private message and make a polite request that they change their username to avoid users landing on their Profile by mistake. Emphasise that it would be in their interest to change if they don't want a large number of Ooredoo customers viewing their profile.
- If this does not work you may need to consider offering cash remuneration.

B. The user has started a Page under the same name and is clearly falsely impersonating the brand i.e. using Ooredoo logo, Page description, posts about Ooredoo

- Look up the channels trademark policy online, these are constantly being changed and updated
- Contact your local representative, where possible, to report the Page or Profile. Be ready with your case to prove the potential harm it could cause Ooredoo's reputation.
- You can report a Facebook Page here: <https://www.facebook.com/help/contact/208282075858952?rdhrc>

For more support links visit:

Appendix

16.2 Channel set up: Page Verification

Twitter and Facebook both offer a blue check mark icon to indicate an official Page.

To have it added to your Page you will need to contact your local representatives with a case that proves the Page is at a high-risk of impersonation. Include examples of Pages or Profiles that have similar names where possible.



Note:

Google+ no longer allows Google+ Pages to apply for verification. It is now only available for Google+ Local Pages (Local Google+ pages are unique from other categories of pages because they have features that allow customers to easily connect with that business's physical location. For example, local pages include a map of the business's location and feature its address, phone number and hours of operation).

16.2 Channel set up: Page Description

Your Page description or Profile bio is one of the major factors that users will take into consideration when deciding to follow you or not. Below are a few things to consider helping you stand out:

- **Be friendly.** Start off by welcoming users to make them feel part of the community. Eg. Welcome to our official Page...; Hello, we're Ooredoo...; Join us...
- **Be specific.** Let people know what you're going to bring to their channel streams — how following you is going to enrich their experience: will it be latest product updates, corporate news or answer customer service questions? Eg. Hello tweeps! Follow us for updates, promos, competitions and the latest news from Ooredoo;
- **Be unique.** Your bio or description should reflect who you are, your values and what you have to offer others. You want to provoke enough interest so that somebody will follow or Like your Page.
- **Manage expectations.** This is most relevant for customer service specific channels. Mention the times that users can expect to receive a response. If the Page or Profile is monitored 24hrs let them know, if it is only during working hours then specify those hours. Eg. Our customer care team is here to answer any queries on weekdays from 9AM-9PM.

Some channels will have a limit on the number of characters allowed in the description. For example a Twitter bio is limited to 160 characters, meaning each word should be carefully selected.

16.3 Content strategy: Tone of Voice

Today consumers are looking to interact and have relationships with brands in ways that were never possible before social media. Brands that succeed in this new form of interaction will be those that show their human-side, revealing to their fans and followers that they are talking to more than a logo.

In many ways, a brand is like a person. The way a person looks and behaves is a big part of who they are. Their choice of words, their tone of voice and their way of speaking create a strong impression of their personality.

It's the same for Ooredoo. We have our own way of talking that helps us to express our brand personality and our attitude. These should feel the same through all the language we use and all the different ways in which we use it. Our tone of voice shapes the way people feel about us, and so it has an effect on their overall experience of Ooredoo.

Genuinely Inspirational

At Ooredoo we are proud to be an inspirational brand. Our brand positioning is centered around:

'inspiring & helping people to live more, delivering against their wants & needs'

And a set of brand pillars: Caring - Connecting – Challenging (3 C's)

We also have a desired brand personality: an inspiring elder brother/sister

16.3 Content strategy: Tone of Voice

From brand pillars and personality we can define how they translate into what we say, how we behave and what we stand for on social:

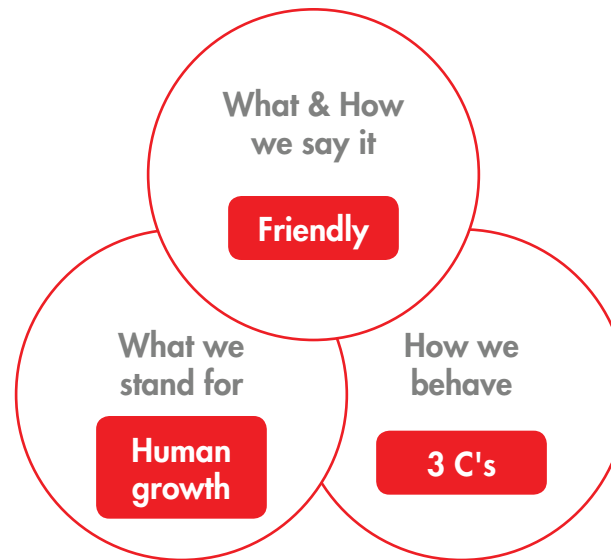

Note:

This guide has been written in line with our Brand Guidelines and provides a practical guide to translating our tone of voice on social media channels.

16.3 Content strategy: What we say and how we say it

As an elder brother or sister we want our writing to be relaxed, accessible and friendly. This means we want to avoid old-fashioned words, which can sound stiff and formal, but at the other extreme, we also want to avoid trendy slang which can make us sound like we're trying too hard or not to be trusted. We prefer clear, everyday language that might be chosen by a mature, relaxed adult. We aim to keep our posts as short as possible, for example the best practice for Facebook post is to keep it to 90 characters. This can be challenging, but so much more rewarding in terms of engagement. Users attention span on social networks is limited the more you ask of them, the less likely they are to engage with your content.

- **Shorter is better.** Keep to the point. So we can miss out on words such as 'that'; 'because'

Instead of

We have introduced a new self-service registration service that lets you avoid waiting in line and puts the control in your hands

Try saying

Self-service - a new, fast registration process that puts you in control

- **Find a better way.** Always ask 'is there a better way to put this?'

Instead of

Unlimited minutes are offered to Gold members only.

Try saying

Once you become a Gold member, you'll have unlimited free minutes

- We wish to use British English and terminology – so "colour" rather than "color"
- We're relaxed so we prefer not to use capital letters and overuse of exclamation marks

16.3 Content strategy: How we behave

In short we are a caring, connecting, challenging elder brother or sister who inspires and helps you get what it is you want in life. Someone who is supportive, trusted and respectful. Someone who is always concerned for you and there for you. Someone who listens to you and understands what you want. Someone, simply, who “gets” you. Yet, as an elder sibling, someone who’s a little more worldly – a little more competent. Someone who takes the initiative and helps you experience new things. Someone who shows you the way to a better tomorrow. And inspires you to go out and get it. In a market where consumers feel alienated by terminology and technologies they may not be familiar with, we can bring a human touch that sets us apart. This comes from recognizing each customer, fan or follower as an individual.

- **Be respectful** – think of your audience as an individual and show a genuine interest in him or her

Insted of

Don't forget that you need to fill in the online application form

Try saying

To help us better understand what you are looking for, please fill in the online application form

- **Be sincere** – sound natural, be convincing and committed

Insted of

Anyone who signs up for the new iPhone, can win a special prize

Try saying

Join in. You deserve to be rewarded

16.3 Content strategy: What we stand for

Human Growth – the heart and soul of our brand. This is what inspires us and drives us forward. Our vision to enrich people lives should be felt in the efforts we make to add value through our content and the way we respond to users' questions always looking for new and better solutions. These words will spark conversations about growth across a variety of topics – social, economic, spiritual and so on.

- **Make a difference** – always look to improve the customers experience

Insted of

We apologise for the inconvenience. We appreciate your feedback and will make sure it is passed on to relevant department.

Try saying

We can understand how frustrating this must have been for you. We have processed a request on your behalf and our customer service team will be in contact within the next 24hrs.

16.3 Content strategy: Developing content territories

To understand how Ooredoo lives and breathes on social media channels we first need to identify the core brand pillars that we want to impress upon our audience through our content. Ooredoo's core brand pillars are: Caring, Connecting and Challenging. These are the areas we want our content to be built around.

By following these content themes we are able to consistently build and reinforce Ooredoo's message with continually updated and fresh content.

3 basic principles to take into consideration when creating content:

- Audience
- Subject Matter
- Channel

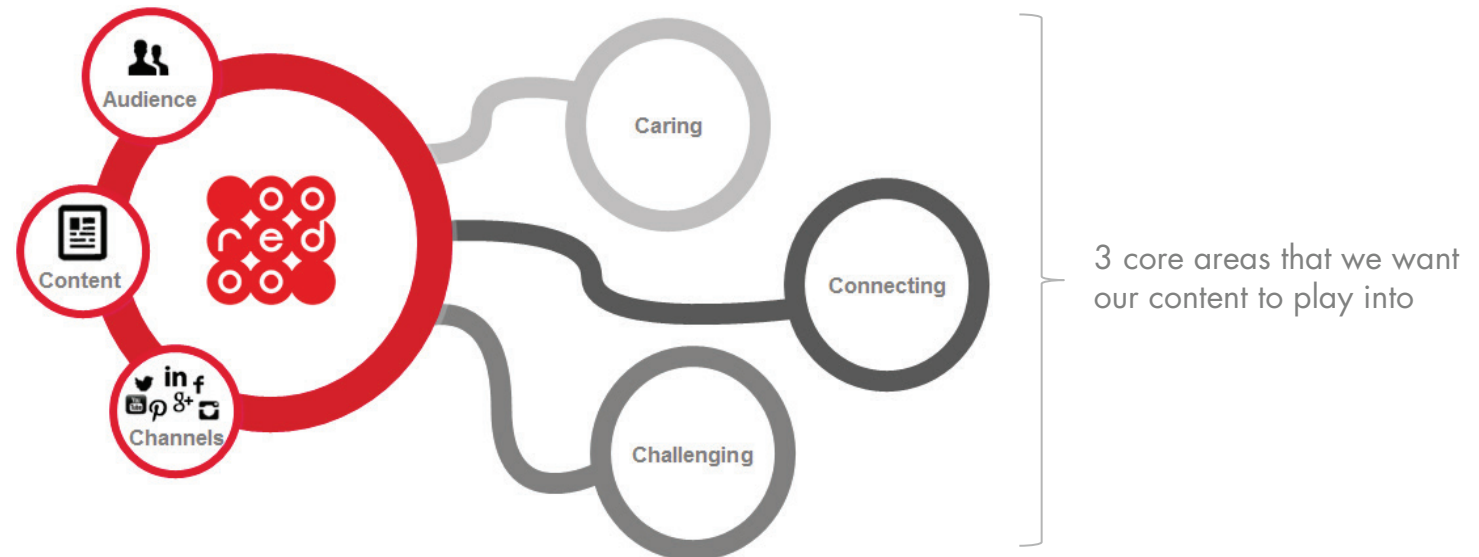

16.3 Content strategy: Developing content territories

Caring

Supporting others

- Dispatch from the Field
- Ooredoo initiatives
- Celebrate culture
- Tips & advice
- Entertain

Connecting

Enabling through technology

- Breaking tech news
- Announcements on new products / services
- Empower
- Listen – online polls and feedback
- Special offers for Facebook Fans

Challenging

Making a difference

- Shared research and knowledge
- New experiences
- Digital Pioneers
- Brand Ambassador programs

16.3 Content strategy: Audience Expectations

Always take your audience expectations into consideration. Ask yourself - does it follow the 4 main reasons users share with their social networks, as shown below:



16.4 Hashtag Planning

Hashtags have become a natural part of conversations happening across social networks. They are a sign of consumers desire to be part of a larger global conversation and connect with others on shared interests and behaviours. From the users point of view hashtags make online searches easier and faster by aggregating conversations according to topic and directly leading them to the topics and conversations that they wish to join and from where they acquire information.

From a business point of view, using hashtags in our social content helps us to ensure that more relevant users join in on conversations that are interesting for us. Relevant participants will help make generating leads easier.

Here are some tips for planning the use of hashtags:

Use a combination of owned-unique hashtags together with popular/trending hashtags, as both serve a purpose.

- Owned-unique hashtags: (it is important to note that owned hashtags do not need to include our brand name, but they should be available, as in not used before, and relevant to the key message)
 - brand building
 - pulling in user generated content
 - collecting competition entries
 - measuring WOM generated around events and new product launches, or offers
- Popular/Trending (eg. #mobile; #tbt)
 - to increase reach and extend our message to a new audience

16.5 Paid, Owned & Earned Media

As the consumer journey between devices, channels and media is becoming more complex, our goal is to reach our audience in the most effective way possible. To do this there are three main channels that we need to leverage:

- **Paid media** initiatives target prospects in an effort to create brand awareness or customer acquisition.
- **Owned media** is the content that we have complete control over and targets our existing community.
- **Earned media** is the natural result of paid or owned media channels, for example when an influential blogger decides to post about our campaign on their popular blog or Twitter profile.

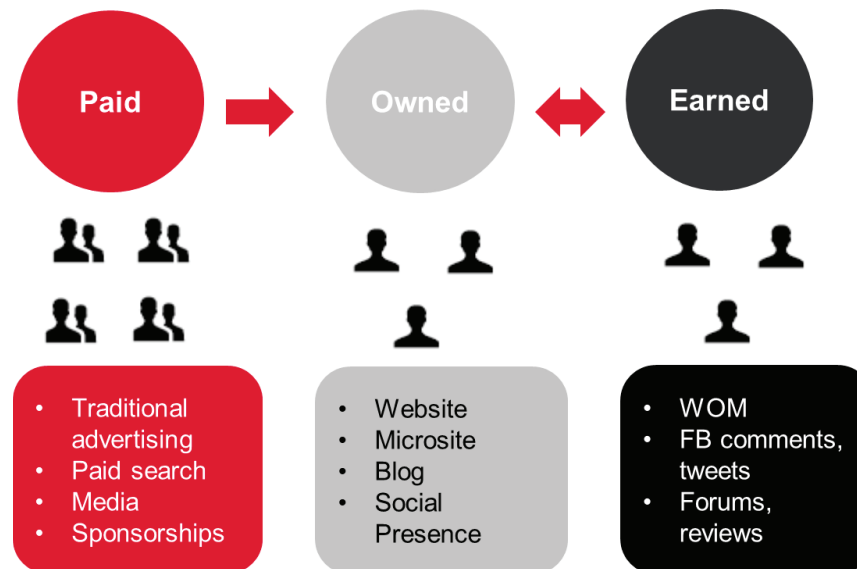

16.5 Paid, Owned & Earned Media

While each one of these channels will play an important role in the content strategy, the real power is when you integrate two or more of the channels. Referred to as **Converged Media**, this is where channels work together enabling us to reach customers exactly where, how, and when they want, regardless of channel, medium, or device, online or offline.

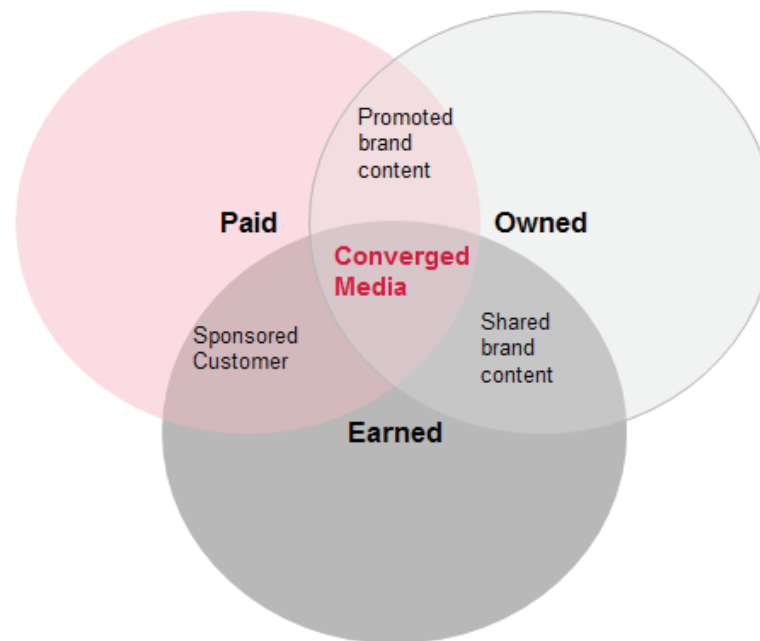

16.6 Paid Media Approach

As the social media space becomes increasingly cluttered with brands competing for consumers' attention, a brand's message can easily become lost in the noise. Paid media provides us with the tools to cut through this clutter and ensure our message is delivered to the right target audience – making this interaction more relevant and effective.

Targeting strategies should start with a broader view of the target audience and this can be drilled down over time as you get to know our audience better, allowing you to focus on speaking to your core target. As targeting capabilities become more precise, based on continually improving audience insights, you will be able to reach out to consumers with a more human approach by connecting one-on-one based on their interests. Targeting is only going to become more innovative and across all devices to engage consumers along their dynamic journey online.

A recommended paid strategy to follow is an always-on approach with increased spend during the launch phase and key marketing activity phases during the year eg. new product launch, contests. This approach of combining fresh updated content with a push from media will help reach a new audience and build top-of-mind awareness while keeping them engaged and coming back to the Page for more.



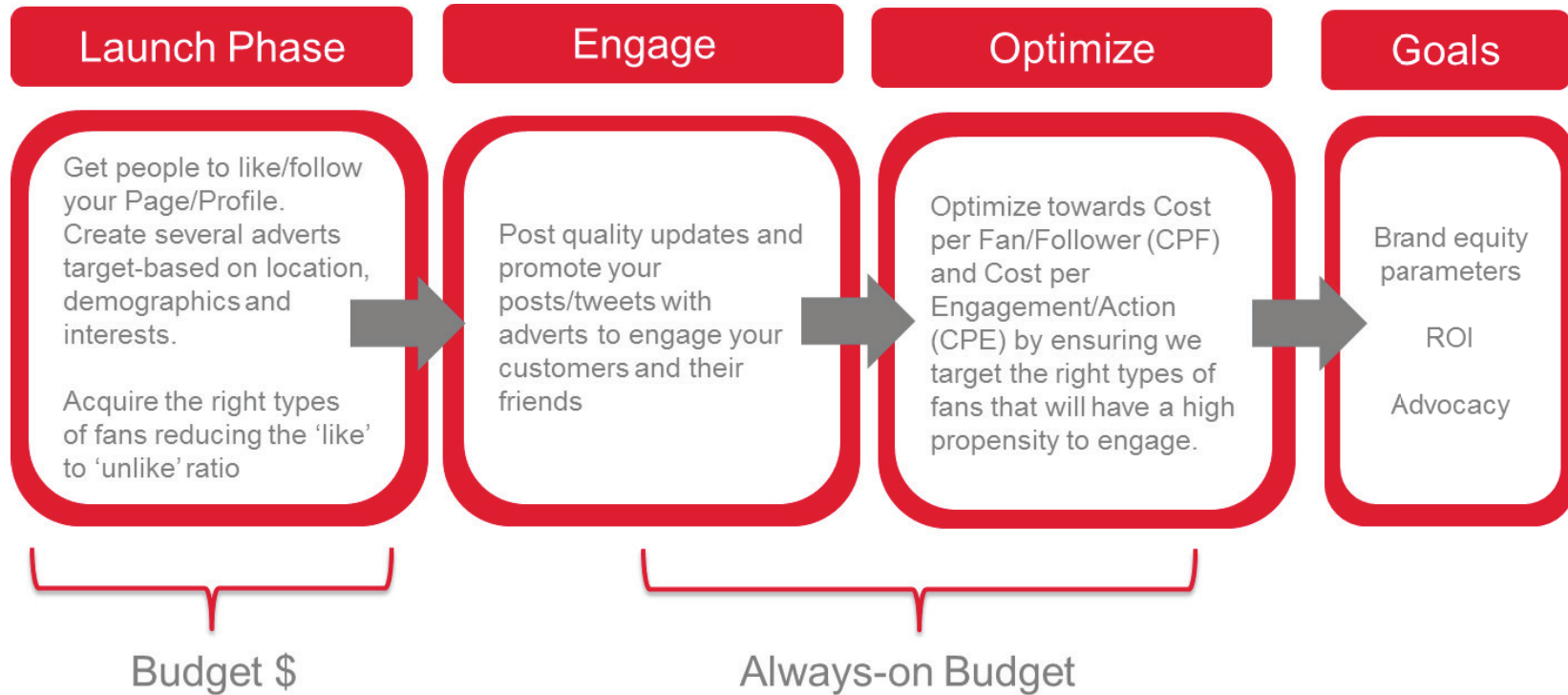

16.6 Paid Media Approach

Below provides an outline of a recommended paid media strategy for social channels:



16.6 Paid Media Approach

The table below provides a summary of the recommended ad types based on desired goals for social channels:

SN	Goal	Products
	Fan Acquisition	Page like ads; Page Like Sponsored Stories [News Feed Recommended]
	Engagement	Page Post Ads, Page Post Ads Sponsored Stories, Reach Block [24 hours product] [News Feed Recommended]
	Follower Acquisition	Promoted Account [Target by Interest and @otheraccounts Followers]
	Engagement	Promoted Tweets [Target by Interest and @otheraccounts Followers]
	Awareness	Promoted Trends [24 hours product]
	Engagement	Sponsored Post [BETA version]
	Awareness / Views	Trueview In-Stream Ads, In-Search Ads, In-Display Ads, Masthead

16.7 Reporting: Determine Social Goals

The first step in your measurement plan should be to generate a list of what you're trying to achieve from your social media efforts. Social media can serve a variety of purposes, from building awareness, answering customer service questions and engaging with a community. What are you trying to accomplish?

When setting these goals it is best to understand what phase of the consumer journey is most important to address. This will differ across each market depending on its stage/position in the market and what content is best suited to fill the communication gap.

16.7 Reporting: Determine Social Goals

Below provides a look at some of the ways social media can be used to support these identified gaps:

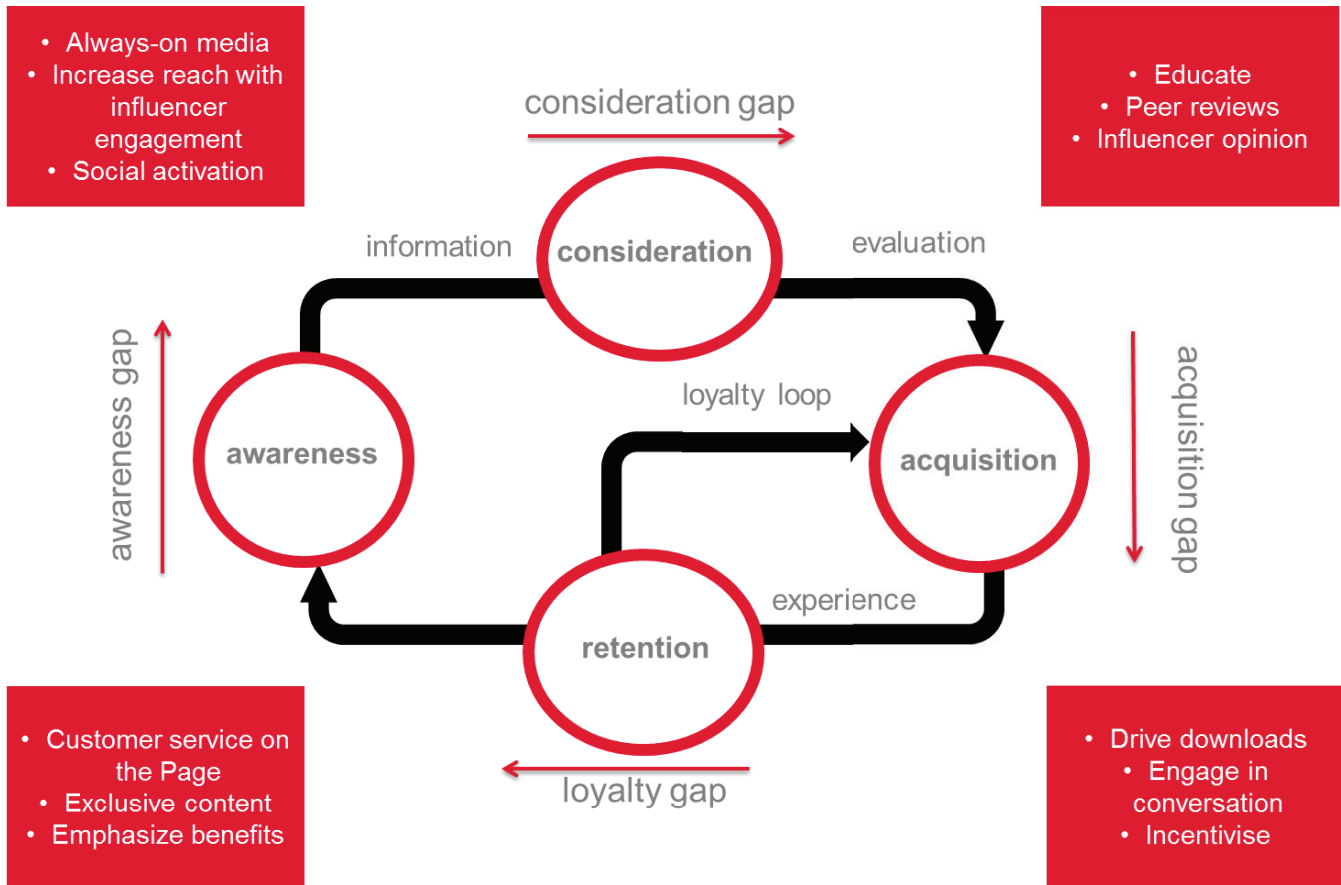

16.7 Reporting: Measuring Success

The next step is to match your goals to actual metrics and behaviors you can measure. Here are a few suggestions of behaviors to measure, based on a few common social media goals.

	APPLICATION(S)	SOCIAL MEDIA	BRAND
1		Engagement	
2		Consideration	
3		Familiarity	
4		Awareness	
5		Cost & Efficiency	

16.7 Reporting



16.7 Reporting

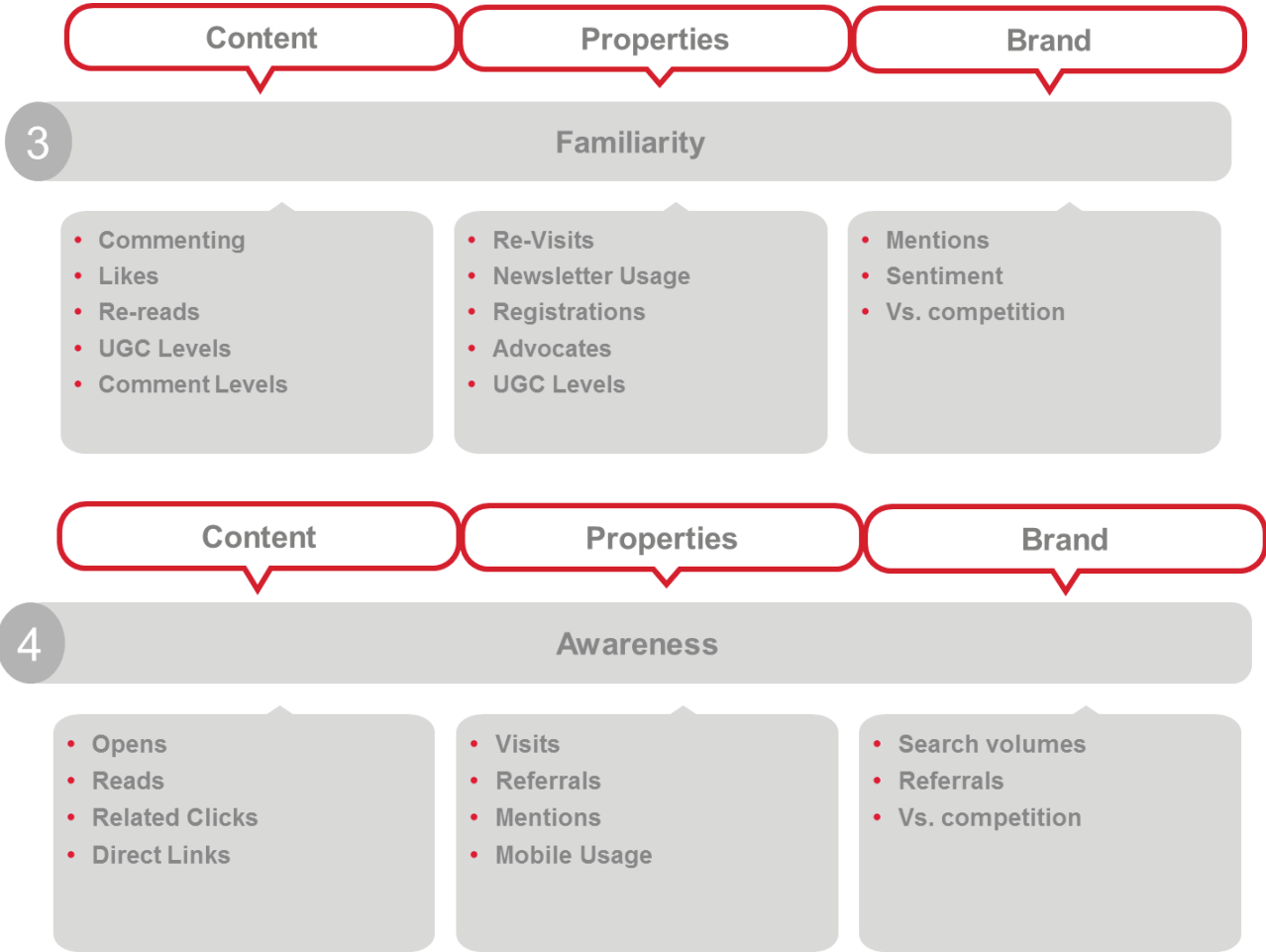

16.7 Reporting

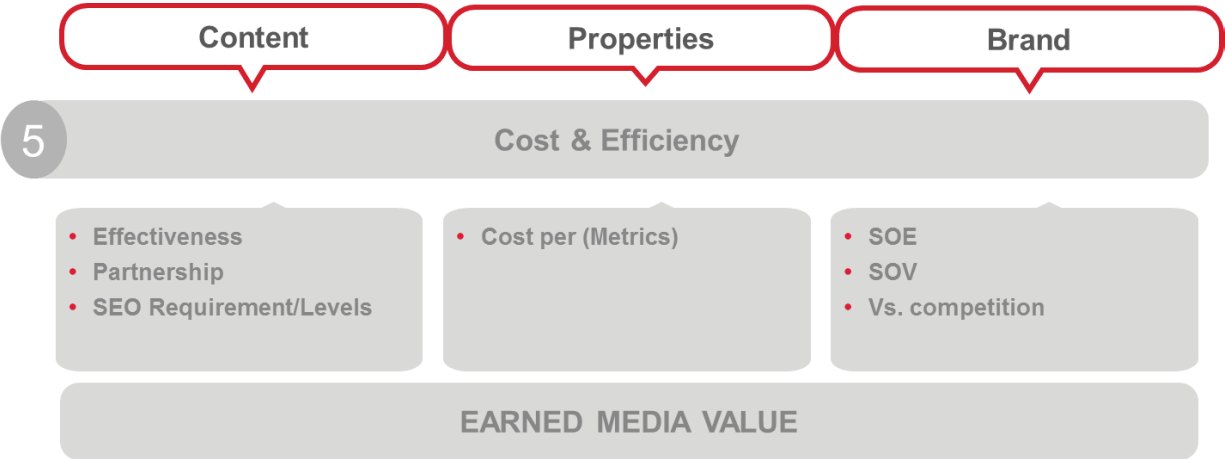

16.7 Reporting: Select your Tools

After you've listed the metrics you want to focus on, now you need to select the tools that actually capture these metrics, and then start measuring.

Tool	Description	Best for	Main benefits
Synthesio	Monitoring	Twitter Facebook Blogs YouTube	Online reputation monitoring Social Customer Support Crisis monitoring Consumer insights and Customer research Influencer identification and Engagement platforms Online campaign management Competitive and business intelligence Arabic capabilities Generate graphical reports
Sysomos	Monitoring	Twitter Blogs Forums	Real-time monitoring In-depth research historical analysis Automated sentiment Influencer identification

16.7 Reporting: Select your Tools

SocialBakers	SocialBakers	Facebook Twitter YouTube	Premier partner to Facebook with same unparalleled access to Twitter Customer insights Measure against competitor and industry benchmarks Measure against KPIs Analyze engagement Generate graphical reports
Statigram	Statigram	Instagram	Follower growth Engagement analysis Optimizations Most engaged users

16.7 Reporting: Monitor and Report

The fourth step is to report your results. Two important questions to nail down are:

- How do your numbers compare to what you expected?
- How do they compare to your competitors' or benchmarks?

The final step is to carefully review your measurement program. How are these metrics doing? Are you missing anything? Was anything unnecessary? Figure out what you can improve, make changes, and then measure some more. Check back in with the goals you set initially and make sure your new metrics actually help you address those goals.

16.8 Influencer engagement: Why engage social influencers?

- Key influencers have high authority in the social space on a certain subject matter
- Authority is based not only on the number of their followers, but on who their followers are themselves
- Amplification of reach is a compound of the key influencers mentions plus other users' replies/shares/re-tweets
- Key influencers have social density spread across other channels

16.8 Influencer engagement: Implementation

Constructing an influencer strategy means building sustained relationships with Influencers. This takes a consistent investment of time and effort and ongoing evaluation of the results to measure effectiveness.

Here are the steps for putting your influence strategy into place:

16.8 Influencer engagement: Identify

For a quantitative measurement of influence you will need to access tools such as Synthesio, SocialBakers or Klout to identify the influencers around a particular subject matter. Let's say you were preparing to launch a new mobile service, you would enter keywords such as "Mobile" AND "Technology" as your search query. A list of the social network users would be displayed based on their ranking of authority and/or affinity to the brand i.e. how many times they mention the brand in their posts.

You will then be able to investigate further into their profile statistics. Key points to note will be:

- **Exposure and reach:** size of their follower base, follower growth rate
- **Amplification:** how often do their followers share/retweet their posts
- **Share of Voice:** how actively are they engaged in their sphere of influence

Once you've identified your influencers define where they fit into your strategy

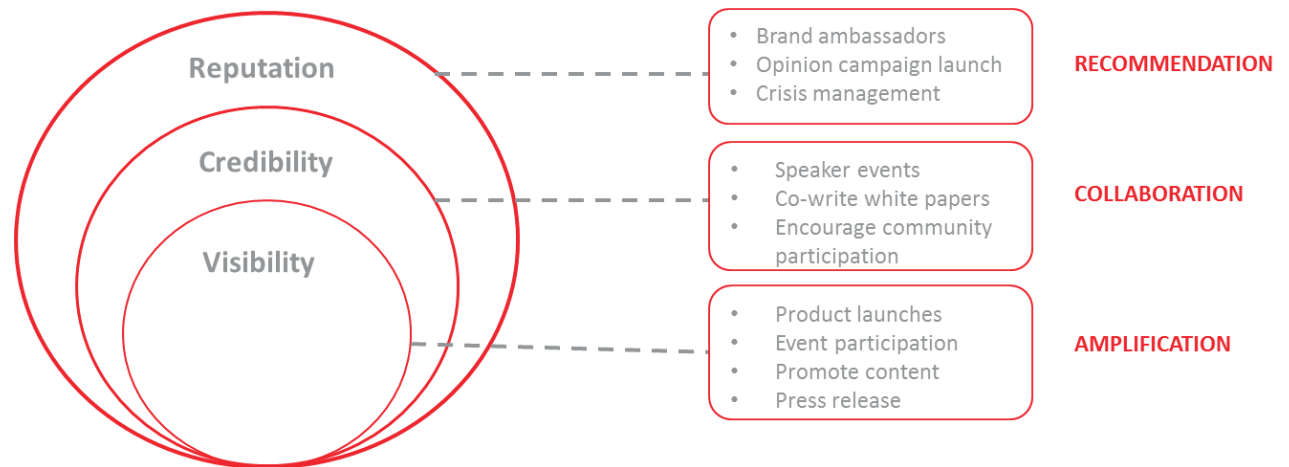

16.8 Influencer engagement: Reach out

First start by getting to know these influencers before you contact them:

- **Identify** which channels they are using to deliver their message, a post on Twitter will be different to the content posted on a blog.
- **Follow:** follow their social networks, sign up for their blog newsletter, share their content with your own communities
- **Refine** your list by monitoring what your influencers publish, you may discover that some aren't as well positioned on the subjects you're interested in as you first thought
- **Personalise:** always take a personalised approach. Visit their latest post to bring a personal touch to making the first contact
- **Engage:** look for ways to add valuable comments, opinion or related links to their posts. This will help show your interest and gain credibility.
- **Connect:** find out about events happening in the industry and use these opportunities to network with influencers' offline. A handshake means a lot more than a Like on Facebook.
- **Record:** keep a record of all interactions with targeted influencers to monitor and measure activity.
- **Be one person, for one brand:** contact with influencers should be made by one person from the organization with the objective to build a long term relationship.

The first step to attract the influencers' attention is through content – content created by Ooredoo,, co-created with the influencer or providing opportunities for content creation. Below are just some examples:

- **Product trials:** provide influencers with exclusive trials of new product launches/updates to build connection to the brand. This trial can also help to build hype and buzz around product news, generate a conversation with the influencer and gather valuable feedback on the product.
- **Product launch events:** gain the influencers buy-in by involving your influencers in build-up to the event, bring them together and make sure they understand the product and how to answer any questions they may get on it. Keep it light and fun, so they don't feel like it is purely commercial.

16.8 Influencer engagement: Reach out

- **Industry events:** collaborate with other notable figures in the sector and invite key influencers to participate and give their take.
- **Informal events:** organise a coffee meet-up or office visit to provide influencers with a glimpse into a day in the life of Ooredoo, what's inspiring you and any special projects that you are working on.
- **Company event:** hold a company event where the influencer will be the moderator or featured guest. Promote the event and the participation of the influencers. Stream the event live online so that it will have greater visibility. Measure the coverage before, during and after the event.
- **Industry articles:** add value to content by providing data specific to the sector and will be useful for influencers to use. Stand out by including user-friendly infographics or videos.
- **Co-write white papers/studies:** build a program to work together on writing an industry white paper, use the opportunity to host meetings together and build stronger relations.
- **Facilitate:** encourage influencer participation for example, you can send a document to fill out that they can use to give you their responses.
- **Share:** distribute collaborative content across your social networks and be sure to mention the participation of the influencer. It is beneficial that Ooredoo publishes the content, so that the influencer can share that same content on their social networks.
- **Associate your content with the influencer's Google+ profile** and other social network profiles. That way you'll have greater visibility on search engines.

16.8 Influencer engagement: Reward

- If you are planning to spread a strictly commercial message, it's likely that the only way to get visibility via influencers will be through a financial reward. Though this approach is recommended in certain cases, it doesn't work for building the reputation of the company in the long term.
- Other means may include exclusive membership in a small group of users who can test your products before everyone else. You also need to reward the social activity of your brand's ambassadors by offering them greater visibility through your channels. Social networks are an immediate means of communication and having an ambassador who can use social networks to communicate about your brand is an essential factor for building visibility. Some of the actions you can take to reward the loyalty of your ambassadors are giving them interviews on your blog or responses to their posts on Twitter.
- Think of influencers as members of your team. Let them participate in your product tests and launches and ask for their opinions in your next campaigns, etc. This will strengthen the relationship between the ambassador and your brand and allow them to be up to date on the activities of your company.

16.8 Influencer engagement: Measure Impact

Engaging key influencers on social media can result in the following results:

- Massive uplift in message reach
- Increase in conversations about Ooredoo by more people
- Owning topics and steering their direction to a place we want
- Building trust and reputation in the brand
- Increasing conversion with trusted peer recommendations

16.8 Influencer engagement: Example

Influencer engagement is an ongoing relationship with peak periods around key marketing activities. During “off periods” influencers are engaged socially on an ongoing basis to maximize the time and effort put into establishing these relationships. Let’s look at one example:

Ooredoo Algeria (OA) is preparing to launch a new mobile service that will benefit entrepreneurs and SMEs. Leading up to and around the launch Ooredoo aims to increase reach and engagement by engaging key influencers. Using social media monitoring tools, OA is able to identify users with high authority around relevant keywords such as “entrepreneur” and “small business”. OA then reaches out to these users with a valuable offer of exclusive content on the subject matter of entrepreneurialism that helps the influencer by providing content for their blog. OA may also choose to feature influencers on a page of their website to help them reach a wider audience and further their credibility.

OA monitors the engagement and reach as a result of each influencer’s activity and develops a list of the most effective influencer relationships. These influencers are then invited to the exclusive launch event, they may co-host other events, feature as speakers or attend entrepreneurship workshops.

As a result influencers build a deeper connection and loyalty to the brand, increasing positive word of mouth and buzz around the new service launch.

16

16.9 Applications: Type of Applications



16.9 Applications: Tactical

- One off applications
- No re-use typically
- Limited content partnerships

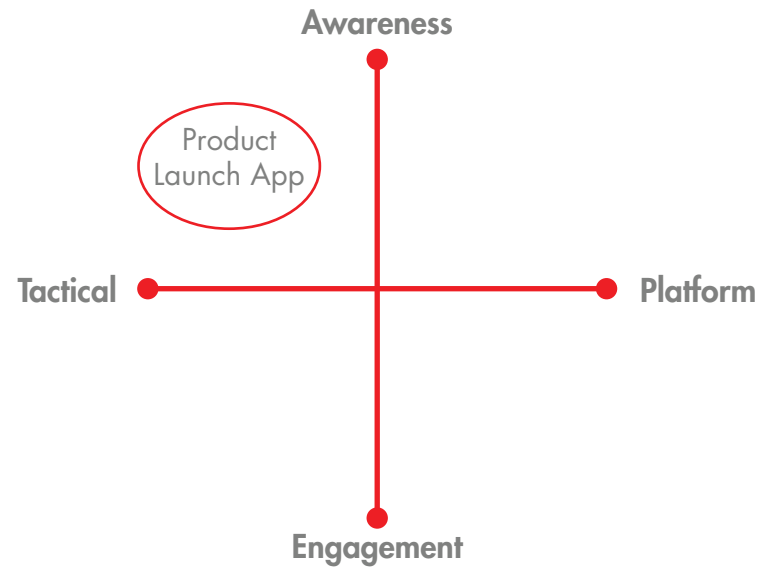

16.9 Applications: Platform

- A series of ongoing activations under brand pillars
- Deeper content partnerships

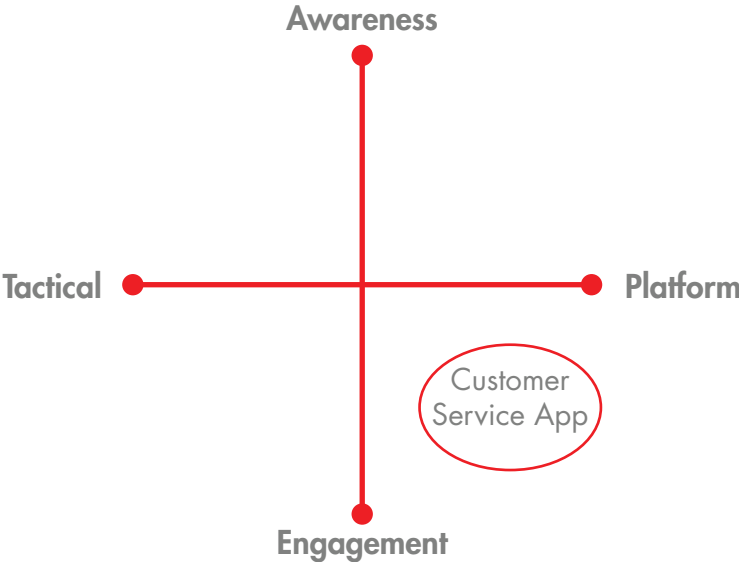

16.9 Applications: Strategic

- Deep integrated content
- Partnerships
- Sophisticated



16.9 Applications: Application checklist

Applications should always deliver against a selection of the key objectives below.

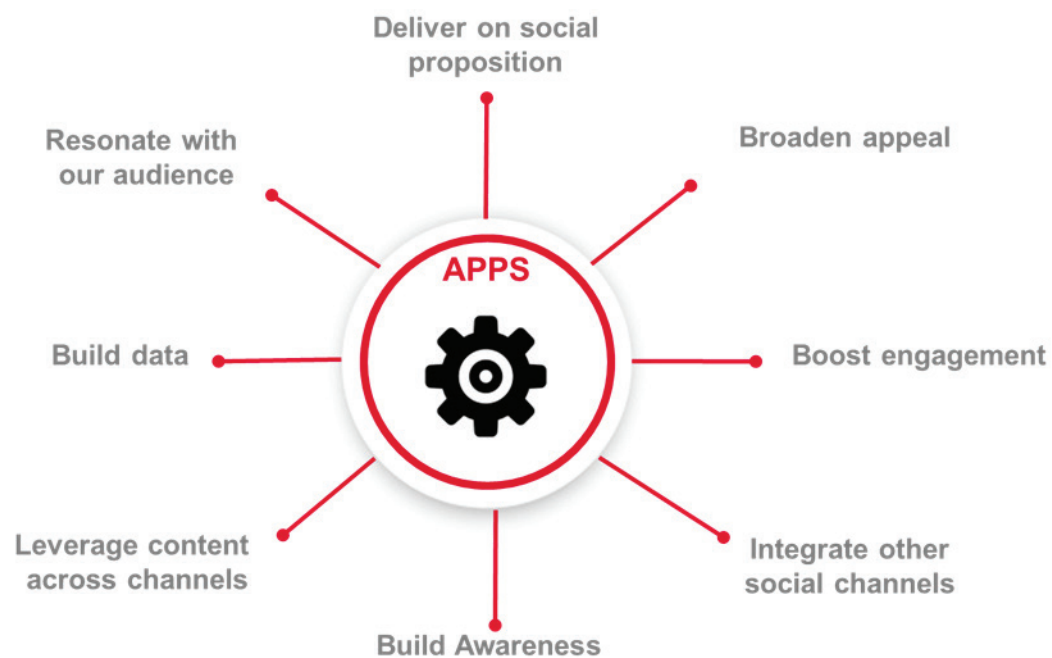

16.10 Best practice: Facebook

TO THE POINT

Attract & keep your fans attention with short copy – ideally 90 characters

INCLUDE IMAGES

Posts with images get the highest amount of engagement on Facebook. Perfect size 800x600

ENGAGE

Build a sense of community by responding to users comments with useful information – not just re-directing them with a website link

KEEP THINGS POSITIVE

Positivity breeds engagement & sharing. It will help inspire & excite users

**PROVIDE A LINK**

Use a URL shortener like Bit.ly

TO THE POINT

Attract & keep your fans attention with short copy – ideally 90 characters

MOBILE FRIENDLY

Use simple imagery that will be easy seen on mobile devices as approx. 60% of your fans will see posts on their phone

16.10 Best practice: Twitter

CALL TO ACTION

Use a clear CTA so your followers know what you want them to do

PUNCTUATION

Don't sacrifice grammar just because you've got 140 characters. Avoid abbreviations & all caps

SHORTEN URLS

Use Bit.ly or Goo.gl to shorten urls and track click through

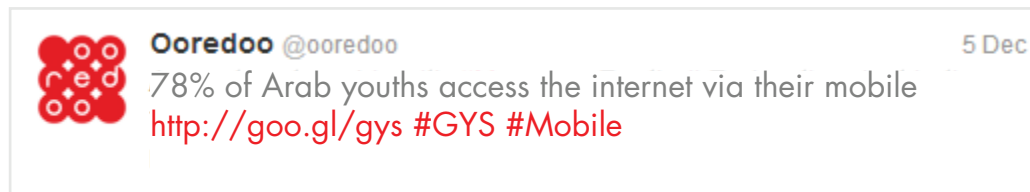
**BRANDED**

Customize your link colour under Design Settings to (CODE)

FORMAT

Use questions, facts and figures to engage viewers & drive Retweets

MENTIONS

Mention influencers to encourage them to engage with you

RETWEET

Retweet relevant content for your audience. Don't forget to leave 20 characters so people can add content

16.10 Best practice: Google+

TRENDING TOPICS

Get involved with the 'Hot topics' to show your brand is keeping up with real-time events. This will also increase your brands visibility.

LINK TO RANK

Post links to your original content so it will get indexed & ranked by Google – brought up in search queries.

USE HASHTAGS

Adding relevant hashtags to your post will help increase reach eg. #Technology

TAG BRANDS & PEOPLE

They'll get a notification & will be more likely to engage with that post

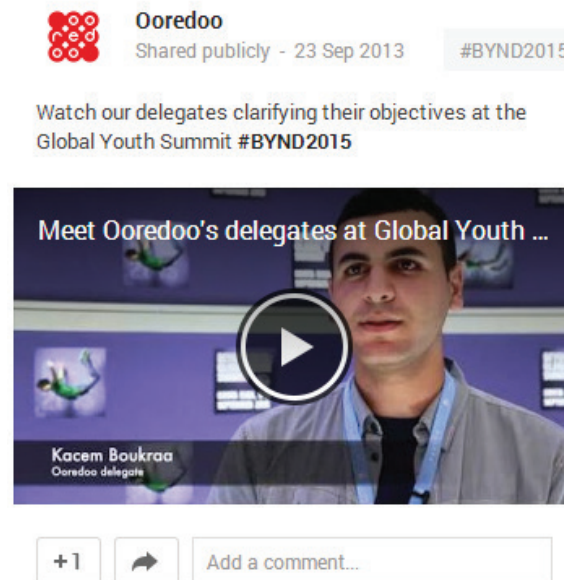
**CREATE CIRCLES**

Create fun names for your circles & group fans or influencers accordingly eg. OO-Reds

USE VIDEOS

Add videos from your YouTube channel with event coverage, behind the scenes, interviews etc.

16.10 Best practice: Instagram

EDITING

Use other apps such as Camera+ & Snapseed, to enhance your photos. Once you get used to editing your feed will have a consistent look & feel.

CAPTIONS

Use relevant photo captions to grab the attention of people and include questions to drive comments.

MEET UP

Organise an Instagram Meetup exclusively for your followers eg. InstaWalk behind the scenes at an event

**BUILD A CONNECTION**

Post photos that users can't see anywhere else by giving them a glimpse behind the scenes – helping them build a connection with the brand.

LEAVE ROOM

Keeping subject of the photo in only two thirds of the screen makes it more attractive to the eye.

ENGAGE WITH HASHTAGS

Create a weekly hashtag challenge with a unique hashtag to engage your followers.

16.10 Best practice: Pinterest

NO HUMAN FACES

Images with no human faces get shared 23% more often than those with human faces.

USE COLOUR

Images with strong colours (red, dark green, pink) get 3x the amount of Likes and Repins.

TELL A STORY

Pin a few carefully chosen pins together to tell a story e.g. a house next to beautiful views



Be brave. Get involved
<http://Ooredoo>
 #Mobile

HIGH (QUALITY) IMAGES

Use high-quality image in vertical format for eye-catching result. The perfect ratio is 2:3 and 4:5

PIN DAILY

Pin fresh content at least once a day & spread your posts out throughout the day.

LITTLE BACKGROUND

Use a compelling background that doesn't take up more than 40% of your image, otherwise you'll see repins decrease by 50%

LINK

Make sure to link pins back to your website for referral traffic

16.10 Best practice: LinkedIn

- Recruitment
 - Post career opportunities as status updates and premium postings
 - Create a group for your customers and another for prospect employers that you want to hire. Engage with conversations with each regarding the relevant topics for their respective fields of interest
 - Use your current employees as brand ambassadors for your company. They should also be open to the public's requests and recommendations in terms of recruitment.
- Opinion Leader
 - LinkedIn Groups & Answers can give you a voice to control in the space of the platform. Use this voice to solidify your position as an Expert in your field
 - Share blog posts on the Page related to industry expertise
 - Connect with journalists, influential people and the movers & shakers of your industry. By creating such a network, you will become a more trusted source.
- Engage

Share articles & posts that would benefit your followers so they can engage in a meaningful discussion with you.

16.11 Support links: Report Trademark Infringement

- Facebook: <https://www.facebook.com/help/contact/208282075858952?rdhc>
- Twitter: <https://support.twitter.com/forms/trademark>
- Instagram: <https://www.facebook.com/help/instagram/contact/636276399721841>
- YouTube: <http://www.youtube.com/yt/copyright/copyright-complaint.html>
- Tumblr: <https://www.tumblr.com/dmca>
- Pinterest: <http://www.pinterest.com/about/copyright/dmca/>

16.11 Support links: Page Verification

- Facebook: <https://www.facebook.com/help/196050490547892>
- Twitter: Verification policies have been updated. While requests are looked at on a case by case basis, verification is separate from factors such as ad spend, follower counts, or Tweet counts. If you'd like to learn more about verified accounts, please visit our FAQ: <http://support.twitter.com/articles/119135>.
- When submitting a verification request this is after we upload the budget into your account, we recommend that your account meet the guidelines outlined below. However, this will not guarantee that your account is verified, as other considerations are made in the process. The main goal of verification is to establish authenticity of identities on Twitter.
 - Company/brand must be national or international
 - Account must be active and publicly available
 - Avatar can't be a Twitter egg. Avatar and/or profile header/background must be using official brand/company artwork
 - Bio must be directly related to business or mission. Official company name should be included in the bio
 - URL to main company web page should be included in the Twitter profile
 - Confirmed contact email address which uses company domain (not a generic Gmail, Yahoo!, Hotmail, etc. domain)
- There are also other ways to show that your account is authentic. We recommend linking your Twitter profile from your official website(s). One way to do this is to include the Twitter follow button to your pages. Here is more information on how to do this: <https://support.twitter.com/articles/20164833>
- Google+ (Local Pages only): <https://support.google.com/plus/answer/1713911?rd=2>

16.11 Support links: Hints and Tips

- Facebook: <https://www.facebook-studio.com/>
- Pinterest: http://business.pinterest.com/assets/pdf/best_practices_en.pdf
- Link Google+ to your website: <https://support.google.com/plus/answer/1713826?hl=en>
- If you want to transfer ownership of a Google+ Page
https://support.google.com/plus/answer/2566473?hl=en&ref_topic=2661706

Advertising

17.1 Overview

There are two types of banners that are covered within these guidelines: Brand banners and Tactical banners. Brand banners promote the brand and are used in related campaigns, whereas Tactical banners are used to promote an offer or a product by Ooredoo and are usually more simple and straight-forward in their messaging and execution.

Although some of the fundamental elements and the guidelines for their application are consistent throughout both types of banners, there are some unique guidelines for each type which are highlighted within each section of this document.

Since the objectives for a Brand and Tactical banner and the campaigns differ, this document offers guidelines that will maintain the consistency in creativity and communication while offering a level of flexibility across the categories.

17.2 Banners

17.2.1 Logo Placement



The Ooredoo logo should always be positioned in the best visual placement within the ad unit. The logo should be present through out the animation of the unit where possible. It maybe left aligned or right aligned depending on the core background visual and what is the overall best placement. On smaller units widths (120x600) the stacked logo is appropriate to use.

17.2.2 Square logo

Square logo to be used whenever we have a vertical banner or a banner size, where the visibility of horizontal is in question.



17.2.3 Logo spacing

Clear space

This is the minimum recommended clear space area and more space around the logotype will always aid visibility.

The clear space around our logo is equal to quarter the height of one logo circle (1/4X)

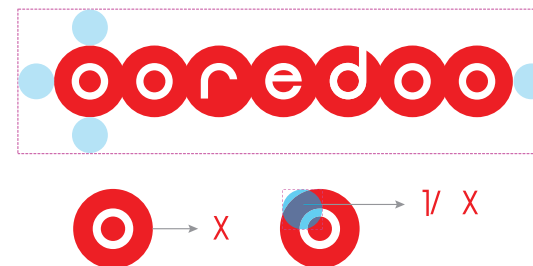

17.2.4 Headline Placement

Ooredoo-Beta
Headline

Futura
Subhead

**Visual**

The visuals should showcase the brand/campaign look and feel.

Depending on the ad unit shape the circle text box should always be placed top left and aligned left. The amount of text lines are donated by the copy length as per the global circle text box guidelines. Please refer to these when constructing headlines.

The font sizes depends on the banner specifications.

For example, 300x250, Headline : Ooredoo, 19pt, no tracking.

When interchanging / animating between headlines the complete circle text box and headline should fade off - with the new headline fading in.

An example of a Horizontal banner.



17.2.5 Endslate

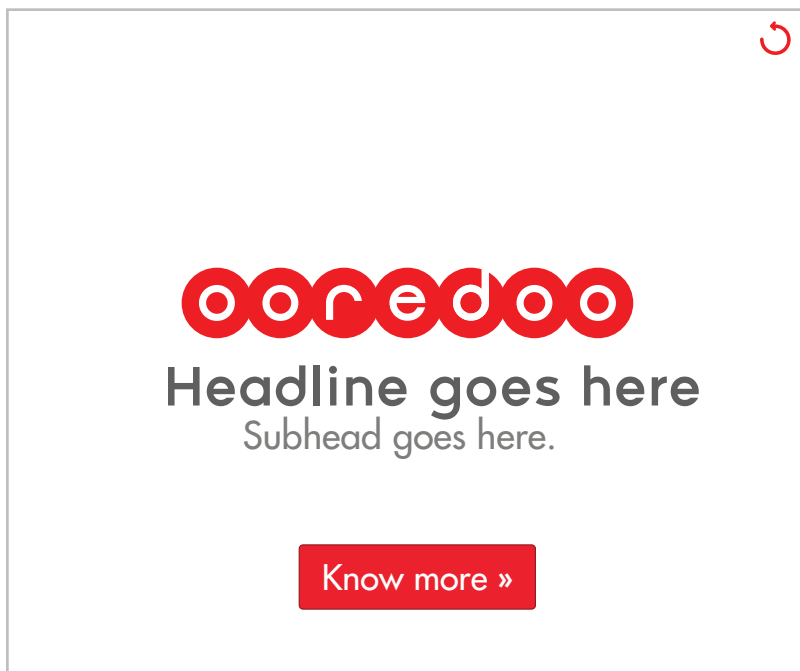

Endplates should be kept clean and concise. Final summary or call to action headline placed center with strong button based CTA.

- Ooredoo-Beta Headline
- Futura Subhead

17.2.6 Banner examples

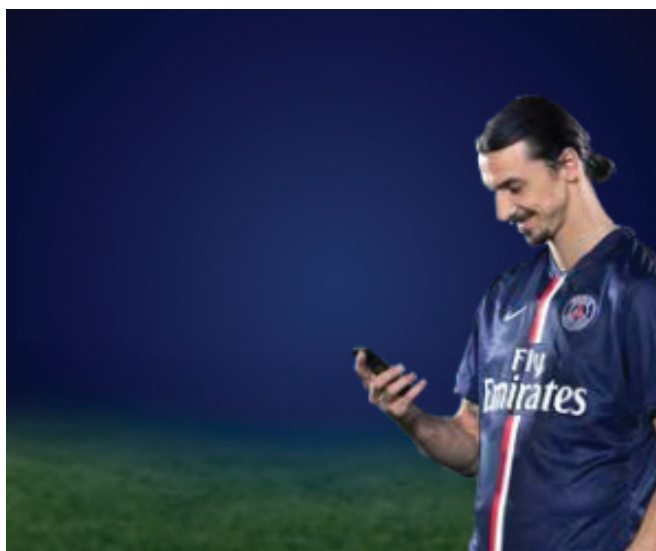

Frame 1

Ensure quality imagery that follow digital brand guidelines.



Frame 2

Headlines and circle text box fade in and out depending on number of communications

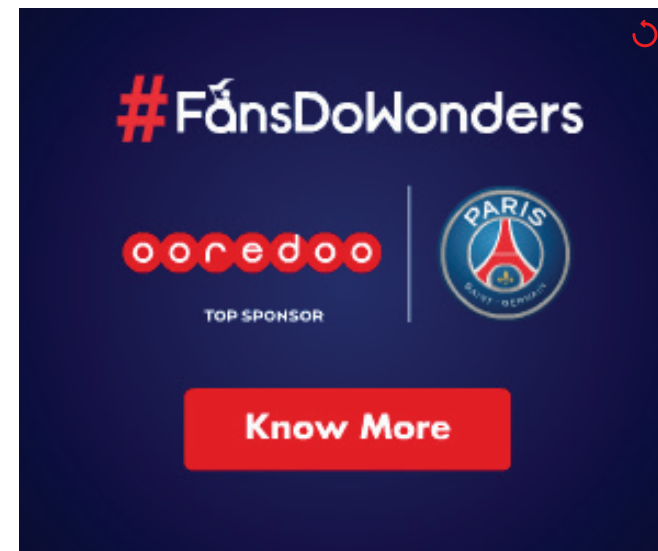

Frame 3

End slates are animated with a clear and clean call to action.

17.2.6 Banner examples



Frame 1

Ensure quality imagery that follow digital brand guidelines.



Frame 2

Headlines and circle text box fade in and out depending on number of communications

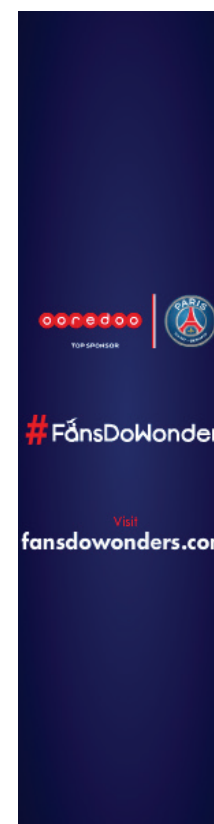

Frame 3

End slates are animated with a clear and clean call to action.

17.3 Tactical banners

17.3.1 Visual, Logo, and Headline usage

Ooredoo-Beta
Headline

Futura
Subhead



Please note: Imagery and assets used are for placement guide only.

Visual

Visual should always showcase or highlight product or service required.

Logo

The logo should be present through out the animation of the unit where possible. It may be left aligned or right aligned depending on the core background visual and what is the overall best placement. On smaller units widths (120x600) the stacked logo is appropriate to use.

Headlines

Headline should be clear and focused on the offer. Price should always be separate in it's own core circle text box as demonstrated in the horizontal and MPU.



17.3.2 Banner examples



Frame 1

Headline pertains directly to the offer, service or product.



Frame 2

Which is followed with price details.



Frame 3

End slate is a the sum of elements with the CTA to buy.

17.2.3 Banner examples

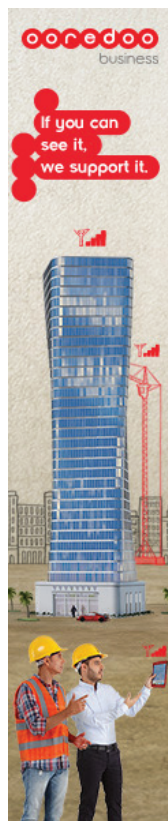

Frame 1

Headline pertains directly to the offer, service or product.

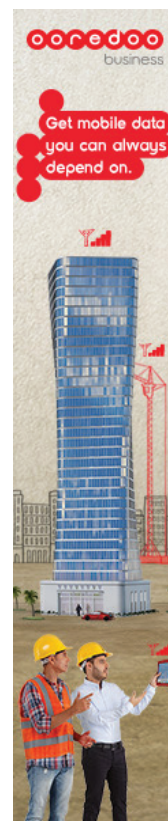

Frame 2

Which is followed with price details.



Frame 3

End slate is a the sum of elements with the CTA to buy.

EDMs and Newsletters are fundamental to communicating **Ooredoo's** product offering as well as personalised information. An important communication medium, that needs to be consistent with the

Ooredoo look and feel. The content may vary, but the brand elements such as the logo, the header image, the typography and the footer should always remain consistent to the guidelines defined below.

18.1.1 Emailer

E-mailers are distinctive with one call to action, i.e. they are used to communicate general information pertaining to the consumer and new offers or deals from Ooredoo.

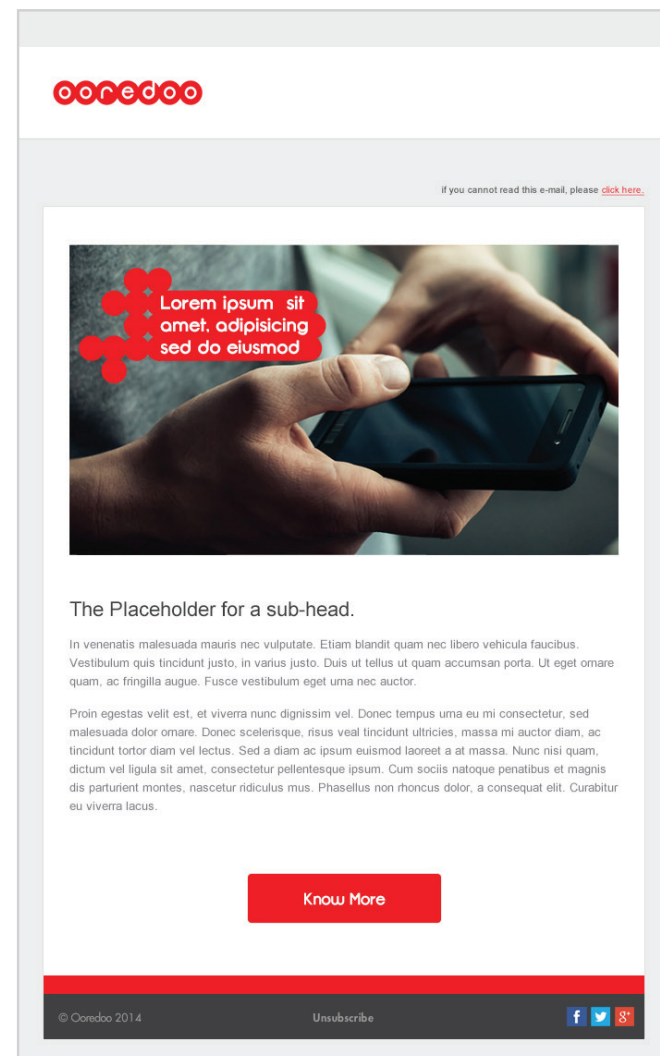

18.1.2 Newsletter

Newsletters are useful to communicate multiple articles, with their own call to action that leads to their specific webpages.

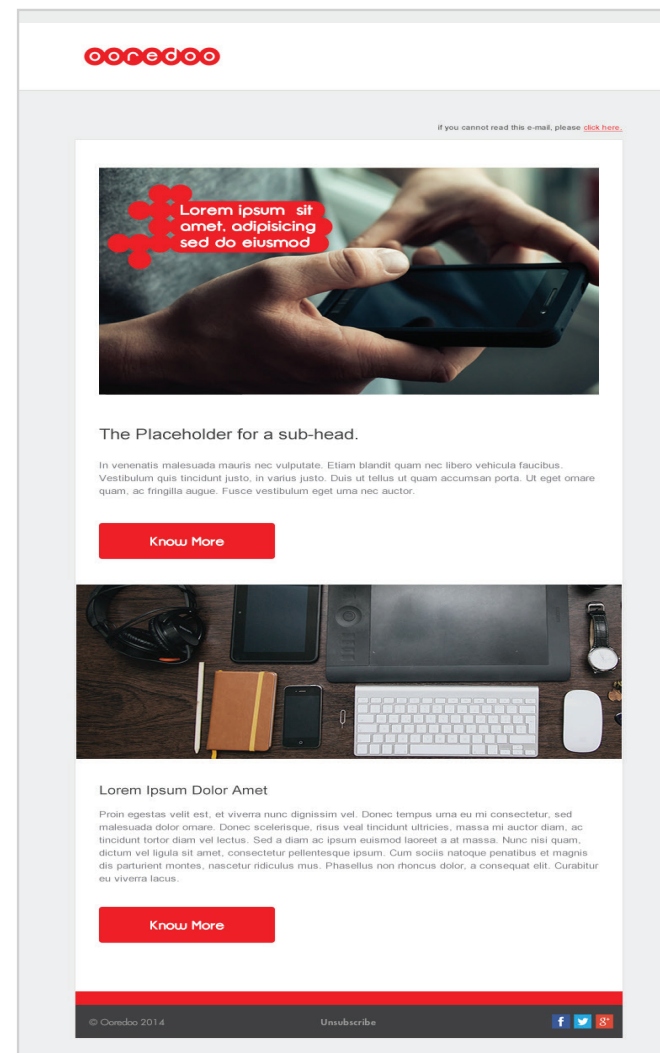

18.2.1 Logo Placement

The horizontal Ooredoo logo should always be placed on the top-left of the e-mailer, on top of a white header with 100% width.

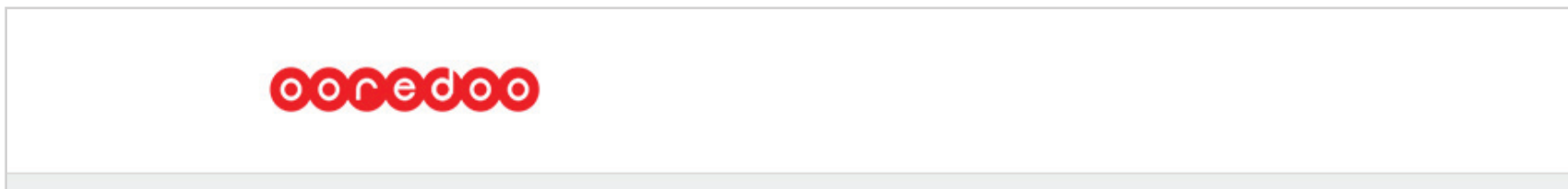

HTML Guidelines

Do not style this logo using css positioning or float. Always put it within a table data cell and text-align it to the left. Don't forget to supply 'alt' attribute value 'Ooredoo' to this logo's image html tag.

18.2.2 Logo size

The logo should be at least 140 px in width and should be aligned with the website guidelines for spacing.



140 px

Logo Size

The logo used in the e-mailers must be at least 140 px wide.

18.2.3 Logo clear space



Clear space

This is the minimum recommended clear space area and more space around the logotype will always aid visibility.

The clear space around our logo is equal to quarter the height of one logo circle (1/4X)

HTML Guidelines

Logo can be cropped along with its top & bottom padding. This will minimize css padding declarations on the containing cell where its height will be more consistent throughout different email clients.

18.3.1 Index

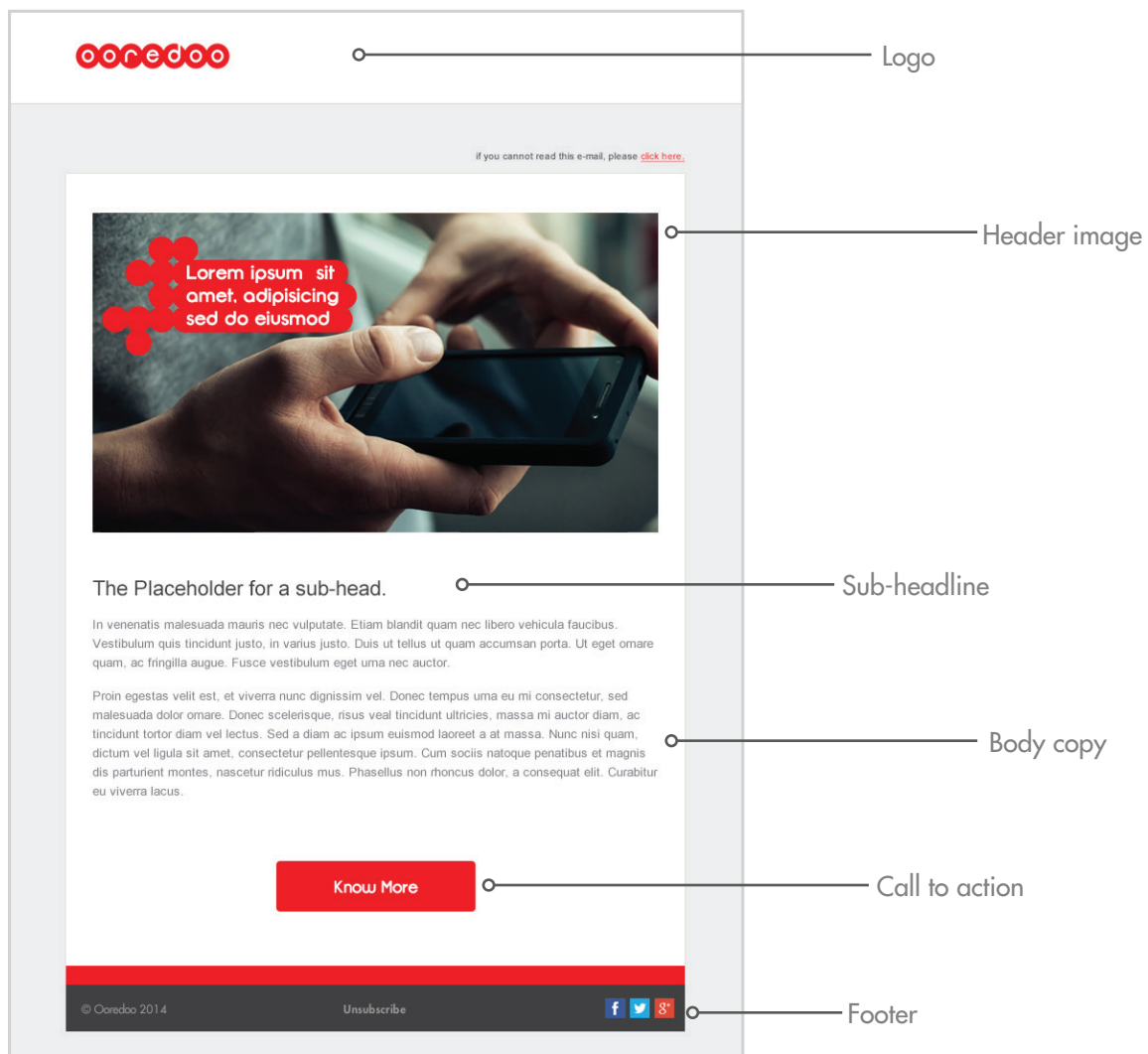

18.3.2 Header image dimensions

The header image is the first content element of an emailer or newsletter.

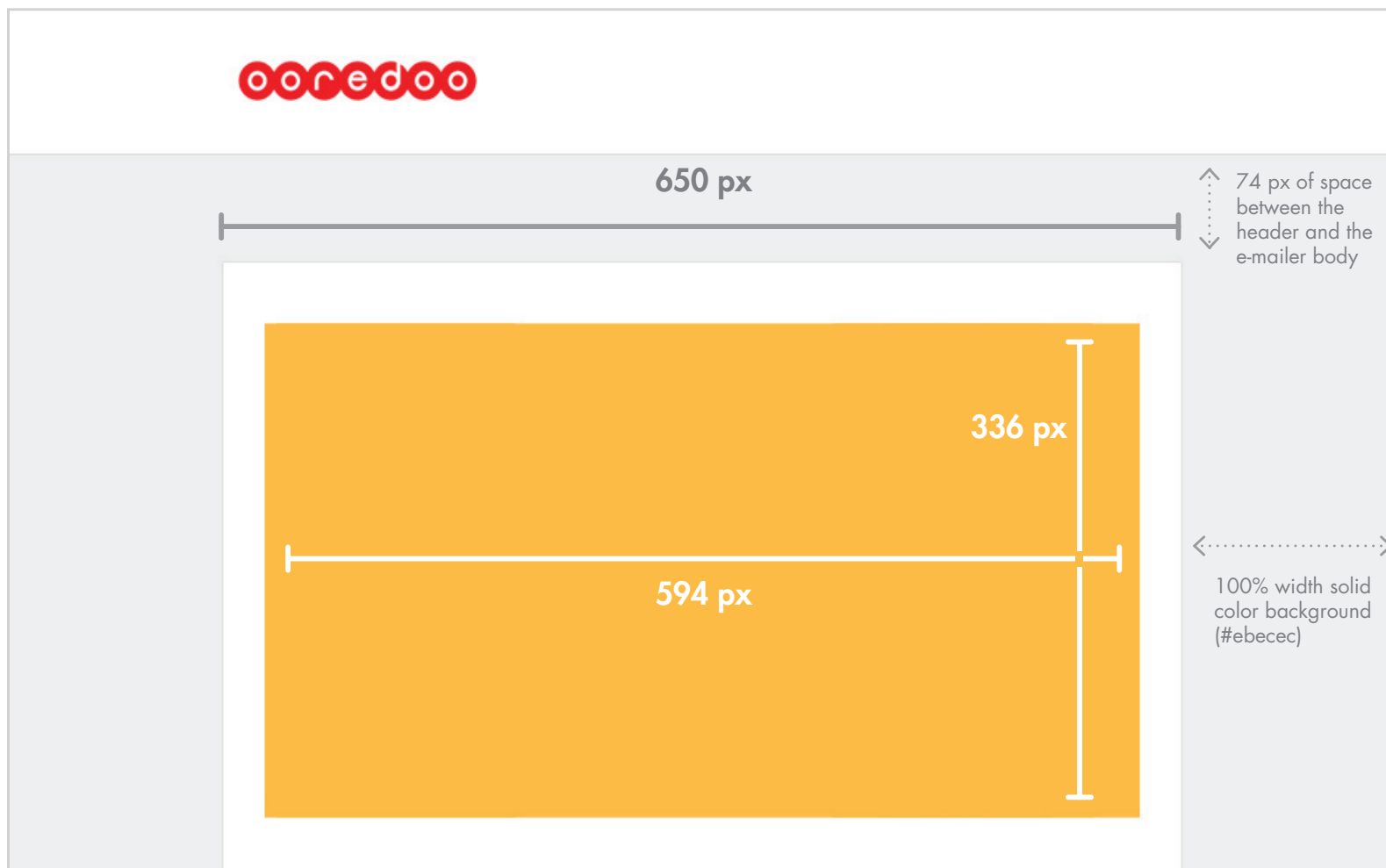

18.3.3 Header Image Format

Use **.gif** format to target all types of audience including subscribers inside corporate environment that still use old email clients and browsers. Use **.png** format to target modern browsers and smartphones.

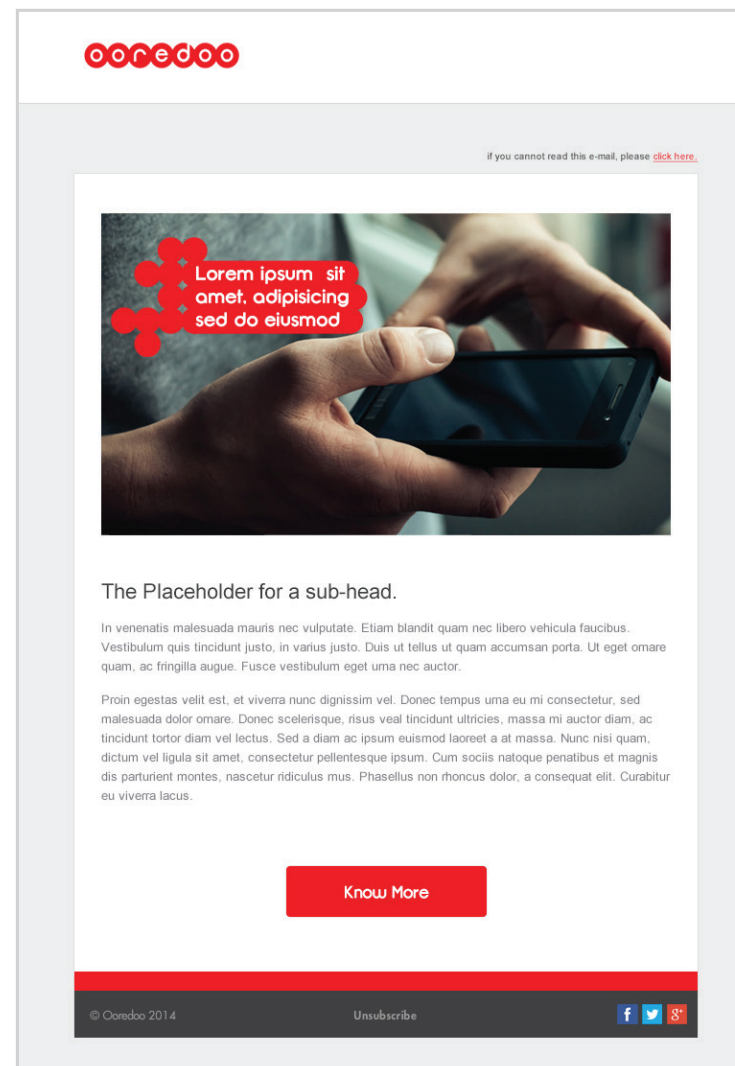

18.3.4 Header Image Headline

The header image is always accompanied with a headline which is either in the circle textbox if it is on top of the image, or as a text headline underneath the image.

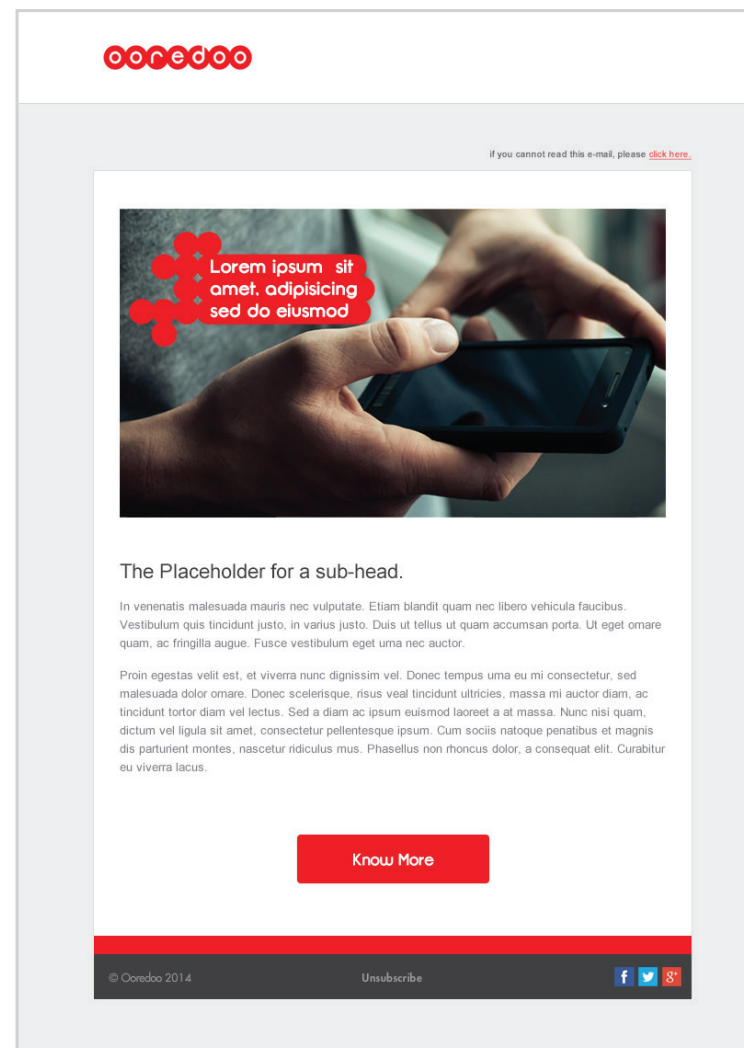

18.3.4.1 Headline within the circle text box

The headline should compliment imagery, mirror the content positioning and be clear and concise. The circle text box should always be aligned left. The amount of text fields are donated by the copy length as per the global circle text box guidelines. Please refer to these when constructing headlines.



— 20 pt, Ooredoo-Beta Bold, Line height = 24 pt; No Tracking.

Related headlines and body copy :

Sub-headline 22 pt, Arial Regular, #414042

Body copy headline 18 pt, Arial Regular, #414042

Body copy 13 pt, Arial Regular, #7f7f85

HTML Guidelines

The circle text box (CTB) headline should be treated as a single image component. This means that the CTB headline should be designed as part of the image, and saved in .jpeg format. Descriptive ALT text should always be provided in the HTML implementation.

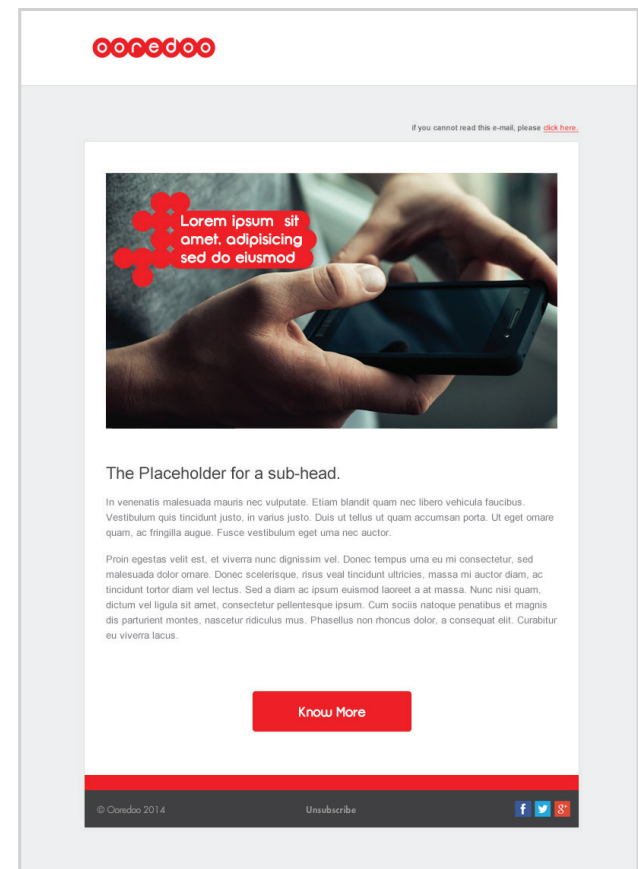

18.3.4.2 Headlines underneath the im-

— Editable headlines are useful in situations where a newsletter is to be personalised. This template allows easy and quick content editing without the need of image slicing.

Headline

30 pt, Arial Regular, #ed1c24

Sub-headline

22 pt, Arial Regular, #414042

Body copy headline

18 pt, Arial Regular, #414042

Body copy

13 pt, Arial Regular, #7f7f85

HTML Guidelines

Avoid compound css declarations. All font styles should be declared explicitly like 'font-family', 'font-size', 'font-weight', 'color', 'line-height' etc. Styles should also be declared inline to the immediate html tag container of the text.

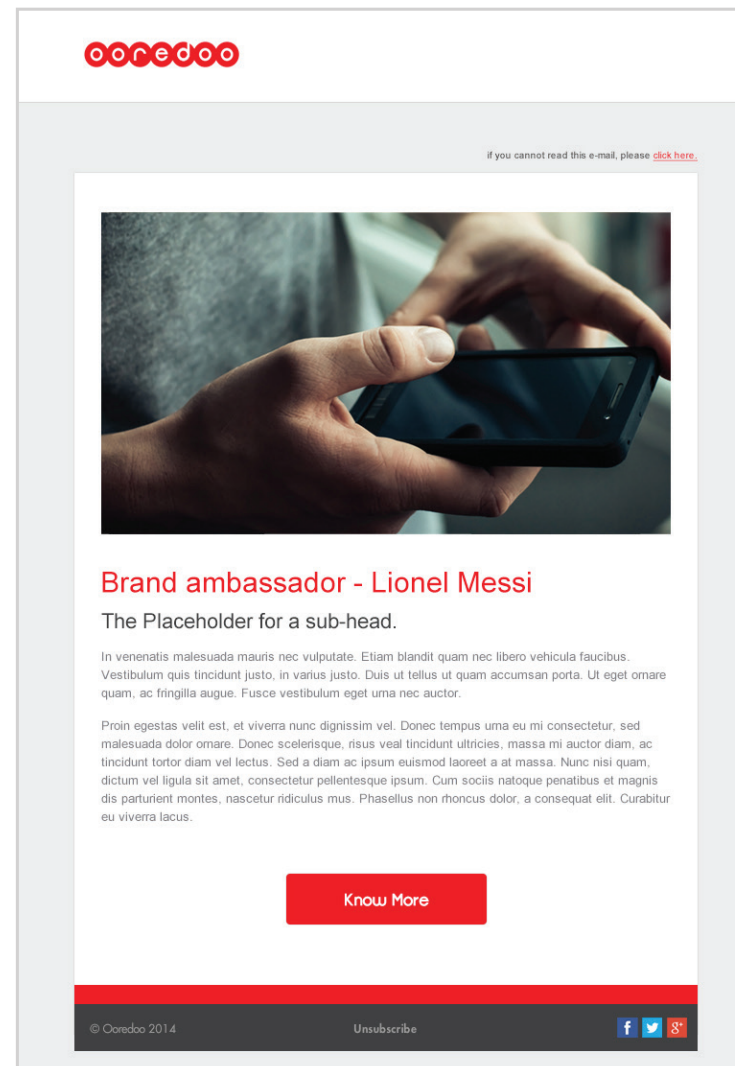

18.3.5 Call to action (CTA)

For Emailer - single article layouts, the CALL TO ACTION (CTA) is center aligned to the layout. For Newsletter - multiple article layouts, the buttons are left aligned to the content. In both cases, the CTA button is above the fold.

4px rounded square; Ooredoo-Beta Bold, 18pt, # FFFFFFF color.

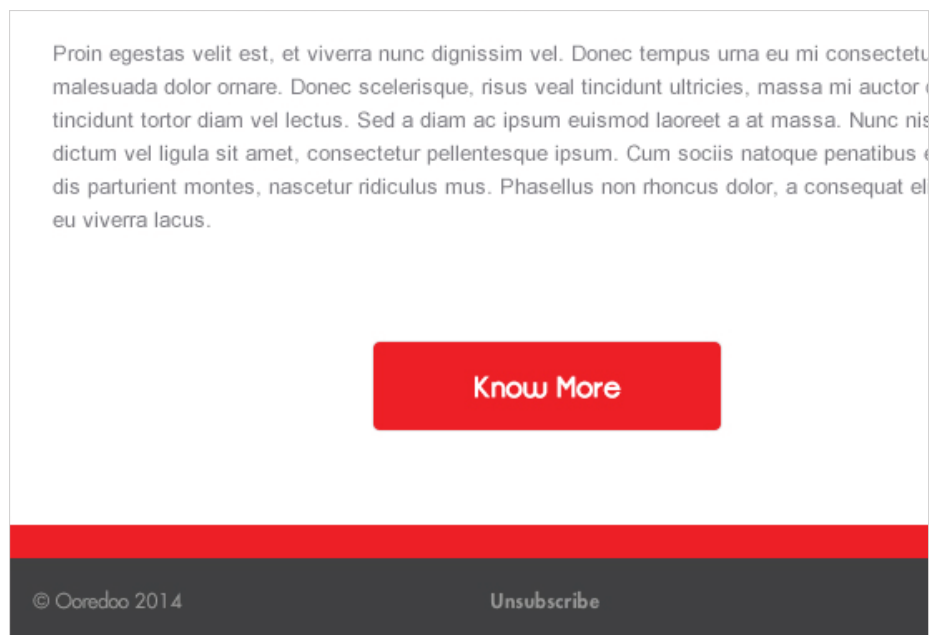

Single article layout, the CTA button is center aligned.

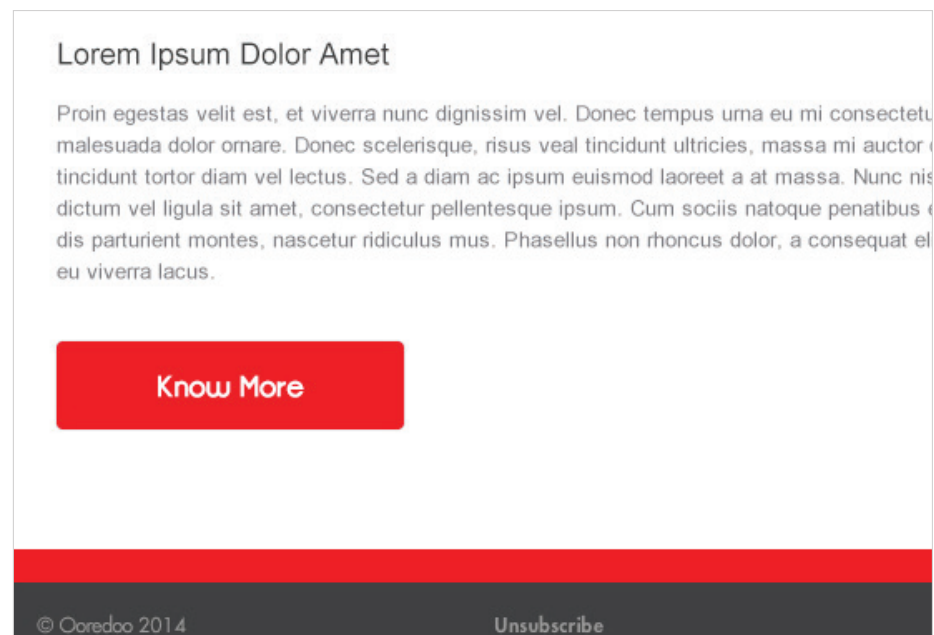

Multiple articles layout, the CTA button is left aligned.

18.3.6 Footer

The Footer is where you place additional information as well as the links to Ooredoo's social websites and an unsubscribe button. Please refer to Best Practices section for more information.

The diagram illustrates the layout of an email footer. It features a central red button labeled "Know More". Below this is a dark grey footer bar with a red top section containing the hex code #ed1c24. The footer bar contains the following elements from left to right: the website URL www.ooredoo.com, the copyright notice © Ooredoo 2014, an Unsubscribe link, the hex code #404142, and three social media icons (Facebook, Twitter, and Google+). Annotations include: a red line pointing to the copyright text with the note "Copyright text guarantees that the design and content are protected and owned by Ooredoo."; a red line pointing to the Unsubscribe link with the note "The unsubscribe link is a mandatory element which always be part of the footer."; a red line pointing to the social icons with the note "Social icons to be placed at the right hand side."; and a red line pointing to the social icons with the note "Fixed size of 22 x 22 px the social icon should be taken from the ooredoo iconography". Dimensions are indicated: a red dashed line shows a height of 20 px for the red bar, and a black dashed line shows a height of 49 px for the dark grey footer bar.

tincidunt tortor diam vel lectus. Sed a diam ac ipsum euismod laoreet a at massa. Nunc nisi quam, dictum vel ligula sit amet, consectetur pellentesque ipsum. Cum sociis natoque penatibus et magnis dis parturient montes, nascetur ridiculus mus. Phasellus non rhoncus dolor, a consequat elit. Curabitur eu viverra lacus.

Know More

#ed1c24 20 px

www.ooredoo.com © Ooredoo 2014 Unsubscribe 49 px #404142 f t g+

Social icons to be placed at the right hand side.

Fixed size of 22 x 22 px the social icon should be taken from the ooredoo iconography

Copyright text guarantees that the design and content are protected and owned by Ooredoo.

The unsubscribe link is a mandatory element which always be part of the footer.

18.4.1 Grid structure

The e-mailers follow a 8 column grid to maintain consistency with the website and other communications. The content itself can be arranged into single column layouts or multiple column layouts.

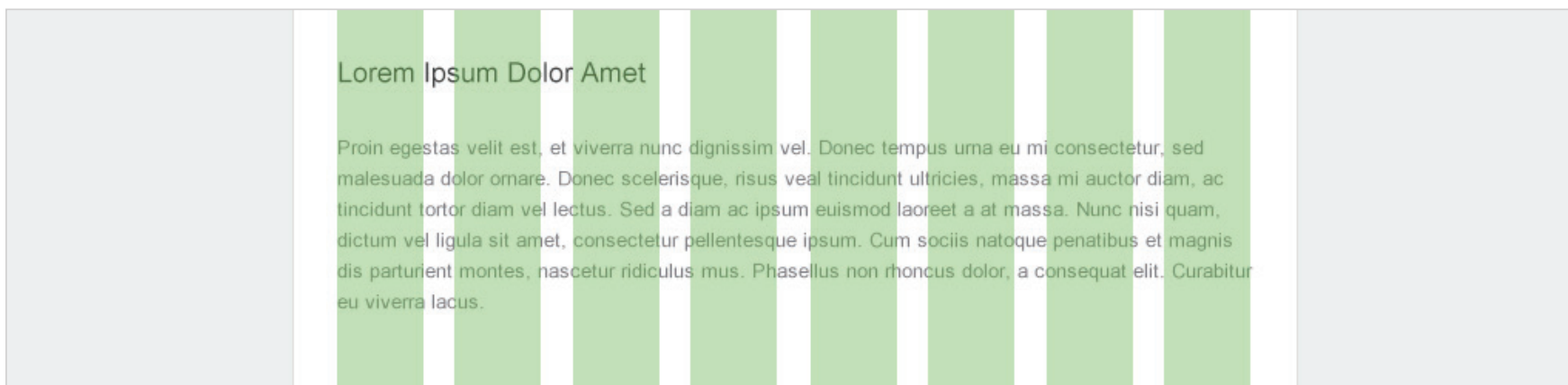

HTML Guidelines

HTML email should be coded and structured using only nested table elements. This is the safest approach for it to work on all email clients and browsers. Layouts can only be single/fluid column or multi-column fixed-width layout. If it is fixed-width, it should not be more than 600px or 650px wide. Height can be taller but a single table element should not exceed 1400px in height.

Some email clients put an automatic page break on a very tall table element, which can result into a broken layout.

Styling html email should consider only the inline CSS approach. Inline means declaring styles only within the 'style' attribute of every tag. Example: `<td style="margin:0; padding: 0; font-family:arial;">`

18.4.2 Emailer - Single article layout

If the target audience is broad and which covers from mobile devices to desktop email clients, the best approach is to use a single column layout.

This layout is easy to implement to make it fluid so it can squeeze in with the smallest mobile screen possible and can scale up its width for larger screens.

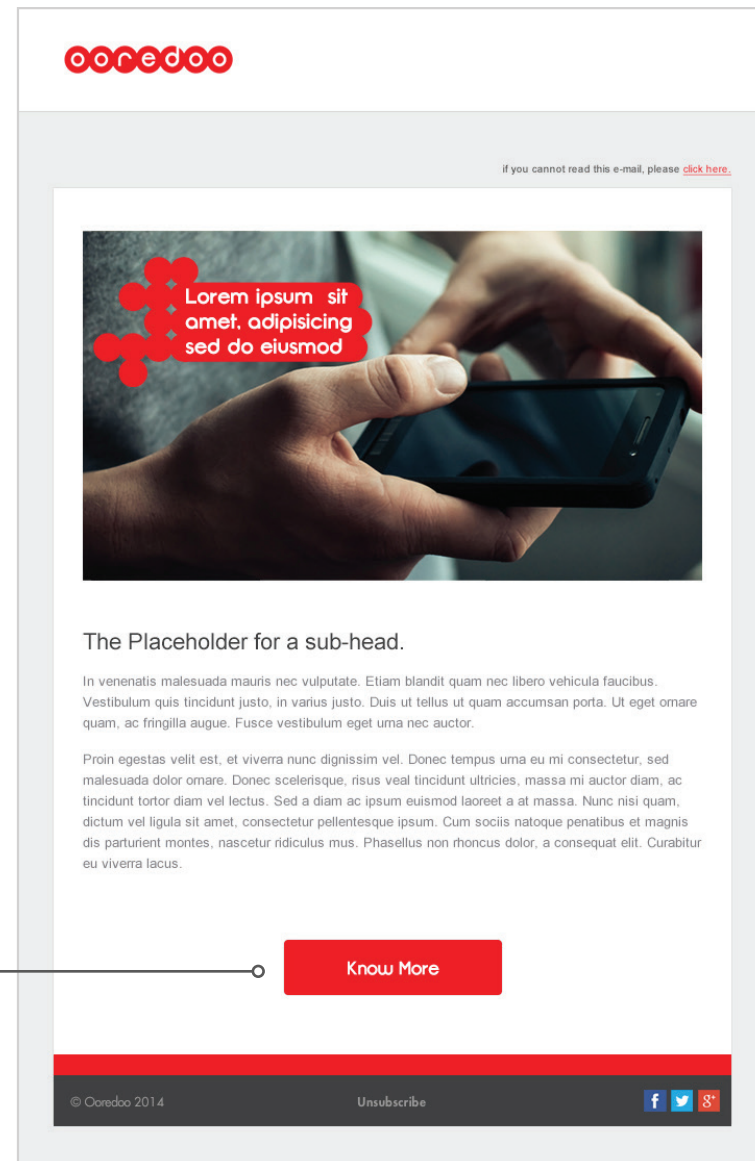

CTA is centered

Know More

18.4.3 Newsletter - Multiple articles layout

Multi-column approach is best fit in presenting different or related types of information in parallel while the email is read or scrolled vertically.

It is a good solution also to break volume of paragraphs into two or more columns to make the copy more readable.

One drawback is it doesn't scale well horizontally and the only option is to have a fixed-width main table container.

Complex columns will result in more nested tables in the html code, so it is recommend to minimize the number of columns and their complexity.

CTA is left aligned

Full screen image dimensions (650x258)

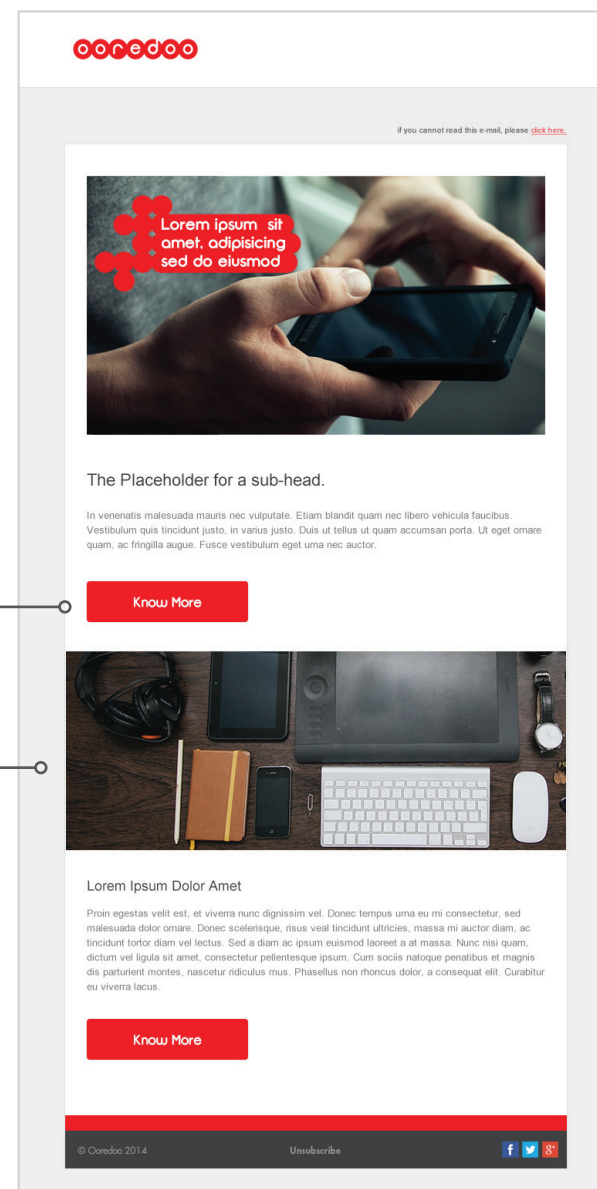

18.5.1 E-mail Service Provider reports

Unlike print and traditional direct marketing, email marketing allows you to measure how many people opened your email and see exactly what they clicked. Email marketing reports (as provided by an Email Service Provider – ESP) give you lots of valuable information to help you improve your campaigns going forward.

ESP reports include the following information:

Sends: how many emails were in the queue before any delivery attempts were made, but after any necessary internal suppression has been performed.

Bounces: when an email that cannot be delivered to the mailbox provider and is sent back to the sender. Classified further as:

Hard bounces: the failed delivery of an email due to a permanent reason, such as a non-existent address.

Soft bounces: the failed delivery of Email due to a temporary issue, such as a full inbox or an unavailable email server on the recipient end.

Delivered: how many emails were transferred to the intended recipient's mailbox provider without generating a bounce or other error.

Opens: when an email recipient viewed the message.

Click-throughs: number of clicks on any links on email by a recipient.

Unsubscribes: number of people that unsubscribed from an email campaign as a direct result of an action taken via a delivered email.

18.5.2 Google Analytics reports - Activity generated on the website

However, these ESP reports don't track activity beyond people arriving onto your website; resulting in a disconnect between email marketing activity and business results.

This information is gained from a digital analytics tool such as Google Analytics.

Google Analytics can be used to show information on how many visits, page views, conversions, transactions and revenue have resulted from your email campaigns.

An example of what this looks like in Google Analytics is shown below:

Campaign ?	Acquisition			Behavior			Conversions eCommerce ▾		
	Sessions ? ↓	% New Sessions ?	New Users ?	Bounce Rate ?	Pages / Session ?	Avg. Session Duration ?	Transactions ?	Revenue ?	Ecommerce Conversion Rate ?
	45,284 <small>% of Total: 0.34% (13,227,745)</small>	15.06% <small>Site Avg: 41.41% (-63.62%)</small>	6,822 <small>% of Total: 0.12% (5,477,378)</small>	10.24% <small>Site Avg: 23.87% (-57.11%)</small>	6.11 <small>Site Avg: 8.48 (-5.31%)</small>	00:07:29 <small>Site Avg: 00:07:05 (5.73%)</small>	130 <small>% of Total: 0.07% (182,757)</small>	\$119,724.63 <small>% of Total: 0.04% (\$286,011,705.84)</small>	0.29% <small>Site Avg: 1.38% (-79.22%)</small>
<input checked="" type="checkbox"/> 1. predep-email	42,736 (94.37%)	15.40%	6,580 (96.45%)	8.85%	6.21	00:07:39	114 (87.69%)	\$102,603.80 (85.70%)	0.27%
<input checked="" type="checkbox"/> 2. Christchurch	2,066 (4.56%)	0.77%	16 (0.23%)	31.51%	4.82	00:04:47	16 (12.31%)	\$17,120.83 (14.30%)	0.77%

This requires two things to be done:

- Configure Google Analytics on your website including conversions and ecommerce transactions (not covered in this document).
- Apply campaign tagging onto all links within your email campaigns.

18.5.2 To apply campaign tagging to your email campaigns, campaign variables need to be added onto all links within your emails.

— The following is the format of each link in the email:

```
http://www.example.com?utm_campaign=[CAMPAIGN-NAME]&utm_medium=email&utm_source=[SOURCE]
```

If a link has a “?” included already, then the following should be used instead:

```
http://www.example.com?page=landing&utm_campaign=[CAMPAIGN-NAME]&utm_medium=email&utm_source=[SOURCE]
```

Variables in **BOLD** are to be replaced as follows:

CAMPAIGN-NAME: the campaign name.

SOURCE: the email list name.

18.5.2

Example:

For a campaign called “Summer 2015” and sent to an email list of “new members”, the following values would be set to the campaign variables:

CAMPAIGN-NAME = summer2015

SOURCE = newmembers

The link <http://www.example.com/> would be changed to

http://www.example.com/?utm_source=newmembers&utm_medium=email&utm_campaign=summer2015

The link <http://www.example.com?page=landing> would be changed to

http://www.example.com?page=landing&utm_source=newmembers&utm_medium=email&utm_campaign=summer2015

For more information and the latest updates:

18.6.1 E-mail Best Practices

- **Optimise your subject line:** The best email subject lines are short, descriptive and provide the reader with a reason to explore your message further. Keep it to 50 characters or less.
- **Use a trustworthy and recognizable "From" name:** The "From" information can be as important as the subject line. As a best practice, the "From:" and subject line should work together. Use the "From" line to indicate and make clear who you are as the sender. As much as possible, this entry should concisely convey who you are and should remain consistent over time.
- **Quality & Frequency:** Two additional factors that can have a big impact on open rates. When readers know what they're going to receive, they're more likely to open. So these high-quality lists of engaged subscribers tend to see the best open rates. If you start with a good list but send too frequently, open rates drop quickly.
- **Relevant content is key:** Relevant content is key to grabbing your subscribers' attention and holding their interest, decreasing the likelihood that your emails will be deleted, ignored or even marked as spam.
- **Keep it short:** Interest in the content of an email diminishes as the email extends below the fold, so keep the most important points of the message near the top.
- **Optimize your headlines:** As the first two words of a headline are the most important, keep them informational. For example, a headline like "3 tips for improving email usability and response rates" could be rephrased as, "Email usability: 3 tips for improving your response rates".
- **Content hierarchy is key:** In addition to including only relevant content in your email, it's necessary to organize your content appropriately. Your subscribers should easily be able to decipher the main CTAs from secondary and tertiary ones.
- **Treat your audience well:** Your newsletter subscribers are usually your most loyal customers and fans, so it is important to treat them better than the regular audience on social networks. It's a good idea send out the newsletter announcing, sales or new products before tweeting such news.
- **Localization Helps:** Personalization, such as including a recipient's first name or last name, didn't significantly improve open rates. Providing localization however, such as including a city name, did improve open rates. structure will save you time for future emails.

18.6.1

- **Include social connection icons linking to your channels:** Email marketing and social media work best when they work hand-in-hand. Provide your subscribers with the opportunity to engage with your brand on different channels, give them the choice.
- **Provide with sharing functionalities:** You can give an option for the subscriber to share the entire email or a specific content block with their social networks. This should be used for public content only such as promotions, and not for any emails containing user's personal data.
- **Promoting social sharing allows you to extend the reach of your emails, giving the opportunity for list growth:** The more people share your email, the more potential you have for opens, clicks and conversions. It also allows you to identify key influencers within your audience, which could help carrying your brand voice.
- **Be clear in your message and if possible provide with an incentive for the subscribers to share.** For instance: Share this email – Re-Tweet this – Post to Facebook – Like this article – The more you share, the more discount you get!
- **Always allow your audience to opt-out:** Make sure there is an unsubscribe link at the bottom of the email. In some countries it is illegal not to do so.
- **Always provide a "View online" option:** Have a link that points to the email content on the web server in case the email doesn't display properly.
- **Optimize for images-off viewing:** Since not all email clients show images automatically, it's important to optimize your emails for images-off viewing. Through the use of ALT text, styled ALT text, background colours, image slicing, bulletproof buttons, and live text, it's possible to optimize your emails for when images are disabled. In addition, be sure to avoid all-image-based emails.
- **Optimize the email file size:** First make sure to optimise all the image sizes for web. The ideal file size of an email is around 20 - 50Kb.
- **Make sure you have the right to use a database:** You should follow the rules of your country. Some countries require the "Opt-in" permission and some other use the "Opt-out" regulation.
- **The importance of testing:** Across desktop, tablet and mobile - on several devices (PC, MAC, iPhone, Android, Blackberry etc.) - on the major email clients (Outlook, Apple mail, Gmail, Yahoo, Windows Live Mail etc.) – and on the major browsers (IE; Firefox; Safari; Google Chrome).

Thank you

This document has been optimised for use with Adobe® Acrobat®. To download the latest free Adobe® Reader® software, please visit www.adobe.com.

No part of this document may be reproduced, modified in a retrieval system or transmitted, in any form or by any means, without the prior permission in writing from the Ooredoo Marketing Department.

Designed & published by
Havas Digital Middle East

HAVAS DIGITAL
UAE

Choueiri Building, 2nd Floor,
Al Sufouh 2 Street, Knowledge Village,
PO Box 21448, Dubai, UAE

T: +971 4455 6700
F: +971 4455 6799
havasdigitalme.com

For more info please contact:
Mohammed Ajawi
Account Director
Mohammed.Ajawi@havasdigitalme.com

ooredoo